



LÄTT

DIRECT FLOW REVERSE OSMOSIS

INSTRUCTION MANUAL

REVERSE OSMOSIS EQUIPMENT

LÄTT

DIRECT FLOW REVERSE OSMOSIS

CONTENTS		P
1	User manual	4
2	Technical manual	8
3	Hygienisation procedure	14
4	Technical data	19

USER'S MANUAL

FOR REVERSE OSMOSIS SYSTEMS

0. MAIN CHARACTERISTICS



CLICK

QUICK AND HIGH
SECURE CONNECTIONS



FILTER CONTROL

AUTOMATIC
MAINTENANCE NOTIFICATION



SOLENOID VALVE

INSTANT CONTROL
SAFETY MESH



AQUASTOP

AUTOMATIC LEAK
DETECTION SYSTEM



DIRECT FLOW

DIRECT PRODUCTION
OF RO WATER



LED STATUS

STATUS
DISPLAYS



HIGH PERFORMANCE MOTOR

HEAVY-DUTY
ENGINE



**SMART
FAUCET**
INTELLIGENT
TAP

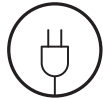

ELECTRONIC ADAPTER

INCREASED SAFETY
AND EFFICIENCY



DOUBLE FLOW

GREATER FLOW
OF WATER DISPENSED



DIRECT ACCESS

EASY ACCESS
AND MAINTENANCE



QUALITY CONTROL

CONTROL
OF CONDUCTIVITY



SOUND WARNINGS

ACOUSTIC
WARNINGS



PRESSURE CONTROL

PROTECTION AGAINST
PRESSURE DROPS



HIGH EFFICIENCY

RECOVERY
IN PRODUCTION

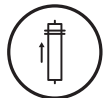

EXCLUSIVE MEMBRANE

ORIGINAL
MEMBRANE



Keep this manual, which includes the service and warranty log sections, so that we can provide you with a better after-sales service.

1. INTRODUCTION

congratulations. You have purchased an excellent domestic water treatment equipment.

This equipment will help you to improve the properties of your water.

2. WHAT IS OSMOSIS?

The natural or direct osmosis is the most common in nature, given that semi-permeable membranes are part of the vast majority of organisms (for example plant roots, organs of our own body, cell membranes, etc ...).

When two solutions of different salt concentrations are separated by a semi-permeable membrane, in a natural way, a flow of water is produced from the solution with the lowest concentration to the one with the highest concentration. This flow continues until concentrations on both sides of the membrane are equal.

When this process is reversed to achieve a flow of water with a lower salt concentration from a higher concentration, sufficient pressure must be applied to the water with the highest concentration on the membrane to overcome the tendency and natural flow of the system. This process is what we call reverse osmosis. Nowadays, reverse osmosis is among the best methods to improve the properties of water by means of a physical system (without the use of chemical products).

The water to be treated exerts pressure on the semi-permeable membrane, so that part of it will be able to pass through the pores of the membrane (osmosis water), while the rest of the water (rejected or with a high concentration of salts) will be diverted to the drain (Fig. 1).

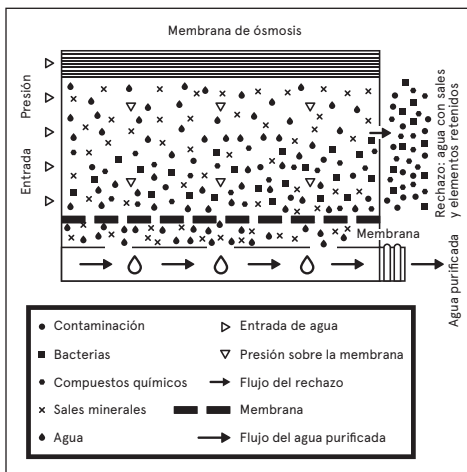

3. PRECAUTIONS

! **ATTENTION:** Read carefully the warnings described in the corresponding section of the Technical Manual.

! **ATTENTION:** This equipment is not a water purifier. If the water to be treated comes from a public supply (and therefore complies with current legislation), this equipment will substantially improve the quality of the water.

The water treatment plants require periodic maintenance by qualified technical personnel in order to guarantee the quality of the water produced and supplied.

3.1. USAGE OF EQUIPMENT

- When you will be gone for more than a week, close the water inlet tap to the equipment, empty it and disconnect it from the power supply (PUMP model). When you return, connect the power supply, open the entrance tap and the faucet. Let the water flow for at least 5 minutes before consuming water.

! **ATTENTION:** After an extended period (more than one month) in which the equipment has been found to be inoperative or not producing water, contact your dealer for proper sanitation and maintenance.

- Remove jars or full bottles and avoid occasional cup extraction for better performance of the equipment.

! **ATTENTION:** Special attention should be devoted to the cleanliness and hygiene of the osmosis faucet, as usual and especially at the time of periodic maintenance and sanitation. To do this, use a disposable single-use sanitizing spray and kitchen towel. Under no circumstances should the hand wipe or multipurpose cloth used for cleaning the kitchen be used. This appliance can be used by children aged 8 years and above and persons with reduced physical, sensory or mental capabilities or lack of experience and knowledge if they have been given supervision or instruction concerning use of the appliance in a safe way and understand the hazards involved. Children shall not play with the appliance. Cleaning and user maintenance shall not be made by children without supervision

3.2. RECOMMENDATIONS FOR THE APPROPRIATE USE OF OSMOSIS WATER

- If you wish to feed any other consumption point with osmosed water (such as a fridge with a bucket dispenser, another tap, etc...), the channelling should not be carried out with a metal tube, as this would give the water a bad taste. Always use plastic tube.

! **ATTENTION:** The water provided by the domestic osmosis equipment is **LOW MINERALIZATION**. The mineral salts needed by the human body are provided mainly by food, especially dairy products and to a less extent by drinking water.

- We recommend not to use aluminium utensils to cook

with osmosed water.

4. THE BASIC OPERATION

The mains water to be treated enters the equipment through the sediment and carbon filter. In this filtration stage the suspended particles, chlorine, its derivatives and other organic substances are kept.

The passage of water into the equipment is controlled by a solenoid shut-off valve.

The water, after being treated in the filtration stage, is propelled towards the reverse osmosis membranes. The equipment includes a pump to increase the pressure, since the pressure of the water on the membrane makes the reverse osmosis process possible.

The osmosed water flows out of the equipment through the tap for consumption. The water waste or excess salts and other dissolved substances is directed to the drain for disposal.

When water is no longer required through the tap, the equipment stops working by means of a maximum pressure switch.

This equipment is equipped with a minimum pressure switch as a safety system, which protects the pump from pressure drops, stopping the equipment and preventing it from running under vacuum.

5. USER INTERFACE

! **ATTENTION:** This equipment comes with an electronic controller that will manage in an efficient way, the functionality and indications of the state in which it is, as well as the different security systems.

The technical data sheet of the equipment describes the states in which the system can be found and the information provided by it (pages 20-22 of this manual).

6. MAINTENANCE

In order to ensure the quality of the water supplied by your equipment, it should be regularly maintained.

Read the corresponding section of the Technical Manual to see the maintenance frequency recommended (page 11 of this manual).

7. IDENTIFICATION AND RESOLUTION OF PROBLEMS

PROBLEMS	POSSIBLE CAUSE	SOLUTION
1. External leakage of the equipment.	Several possible causes.	Call for service.
2. No production.	<ol style="list-style-type: none"> 1. No water supply. 2. No power supply. 3. Leak sensor activated. 	<ol style="list-style-type: none"> 1. Allow the supply to return. 2. Check your home's power supply. If the problem is still not solved, call for service. 3. Leak sensor activated. If the leak is undetected, wipe the bottom of the equipment together with the leak sensor. If it keeps happening, call for service.
3. Low production.	<ol style="list-style-type: none"> 1. Power key partially closed. 2. Filters / membrane in poor condition or exhausted. 	<ol style="list-style-type: none"> 1. Open completely. 2. Call for service.
4. Excessive production.	Several possible causes.	Call for service.
5. Unpleasant taste and smell.	Several possible causes.	Call for service.
6. Whitish water color.	Air in the system. Micro air bubbles that disappear after a few seconds.	It is not a problem. The appearance will fade as the air inside the equipment is removed.
7. Continuous dripping noise in drain.	Several possible causes.	Call for service.
8. Equipment does not start.	<ol style="list-style-type: none"> 1. No water supply. 2. No power supply. 3. Leak sensor activated. 	<ol style="list-style-type: none"> 1. Check the condition of the general key and the entrance of the equipment. 2. Check the general power supply. If the problem is not solved, call for service. 3. If the leak is not detected, dry the bottom of the equipment along with the leak sensor. If it recurs, call for service.
9. The equipment stops and starts constantly.	Several possible causes.	Call for service.
10. Equipment constantly carries water down the drain.	<ol style="list-style-type: none"> 1. Deteriorated inlet solenoid valve. 2. Anti-return of deteriorated production. 	<ol style="list-style-type: none"> 1. Check and replace. 2. Check and replace.

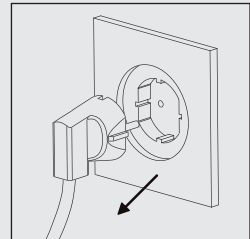
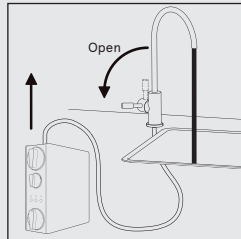
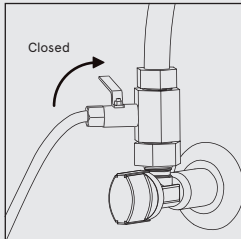

Read the INTERFACE section of the Technical Data Sheet. In case of malfunction, contact the SAT and proceed as indicated: Close the entrance key. Open the tap to depressurise the system and then disconnect the plug.

TECHNICAL MANUAL

FOR REVERSE OSMOSIS EQUIPMENT

1. MAIN FEATURES

APPLICATION

Water treatment
Reverse osmosis

Usage

To improve the characteristics of drinking water (complying with the requirements of the European Drinking Water Directive 98/83 or its national transpositions in the different Member States of the European Community).

Modifications by reduction or contribution

- Reverse osmosis water treatment is able to reduce concentrations of salts and other substances by high percentages.
- Minimum reduction* of certain compounds and parameters:

Sodium: 90%.
Calcium: 90%.
Sulphate: 90%.
Chloride: 90%.
Total hardness: 90%.
Conductivity: 90%.

* Depending on the characteristics of the water to be treated (at the exit of the membrane). These values may vary depending on the type of post-filter incorporated in the equipment and/or regulation of the mixing valve (if incorporated).

OPERATIONAL LIMITS

	PUMP UNIT
Pressure (max./min.):	4 bar - 1 bar (400kPa-100kPa) .
TDS (max.):	1500ppm.
Temperature (max./min.):	38 °C - 5 °C.
Hardness (max.):	15 °HF. **

! **ATTENTION:** *If you have any questions regarding the installation, use or maintenance of this equipment, please contact your dealer's technical support service (S. A. T.).*

2. PRECAUTIONS

! **ATTENTION:** the equipments ARE NOT WATER POTABILIZERS. If the water to be treated comes from a public supply (and therefore complies with current legislation), this equipment will substantially improve the quality of the water.

! **ATTENTION:** If the water to be treated does not come from a public supply network or originates from an unknown source, it will be necessary to carry out a physical-chemical and bacteriological analysis of the water to ensure its correct potabilisation by applying the techniques and equipment appropriate to each need, PRIOR TO THE INSTALLATION of the equipment. Contact your distributor for advice on the most suitable treatment for your case.

2.1 CONDITIONS FOR THE CORRECT OPERATION OF THE EQUIPMENT

- The equipment should not be supplied with hot water (T>38°C).
- The ambient temperature should be between 4° and 45°C.
- For water with salinity higher than 1500 ppm consult your distributor.
- It is recommended that the water to be treated be decalcified or with a maximum hardness of 15 °HF so as to obtain optimum performance from the equipment.

- If the water to be treated has a hardness greater than 15 °HF, this could lead to a reduction in the life of the membrane and in the performance of the equipment.

- In case the water contains a concentration higher than 1.2 ppm of total chlorine, it is recommended the installation of an active carbon dechlorination filter to reduce the concentration of chlorine in the water and thus protect and extend the life of the equipment components.

in cases where the water to be treated contains:

High concentrations of iron and manganese (Greater than 1ppm measured at rejection) of the machine).

Prolonged hyperchlorations over time.

Sludge or turbidity greater than 3 NTUs.

A nitrate concentration higher than 100 ppm.

A concentration of sulfates higher than 250 ppm.

- Contact your distributor for advice on the most suitable pre-treatment for your case, in order to ensure proper operation of the equipment, avoid damage to components and ensure the quality of the water supplied.

- This equipment should not be installed either lying down or tilted (2), because the leakage sensor would become disabled.

If the equipment is full of water, the distribution of weights in an unforeseen position could cause some connecting element to be forced, which could cause malfunction, damage to components of the equipment or loss of water.

- The installation site must have sufficient space for the appliance itself, its accessories, connections and for convenient maintenance (3).

- Under no circumstances should the equipment be installed outdoors (4).

- The environment in which equipment and taps are installed must have adequate hygienic-sanitary conditions.

- The appliance is only to be used with the power supply unit provided with the appliance.

- The appliance must only be supplied at safety extra low voltage.

- Avoid external dripping on the equipment from pipes, drains, etc.

! ATTENTION: The equipment must not be installed next to a heat source or directly receiving a flow of hot air over it (dryer, refrigerator, etc.).

- The new hose-sets supplied with the appliance are to be used and that old hose-sets should not be reused.

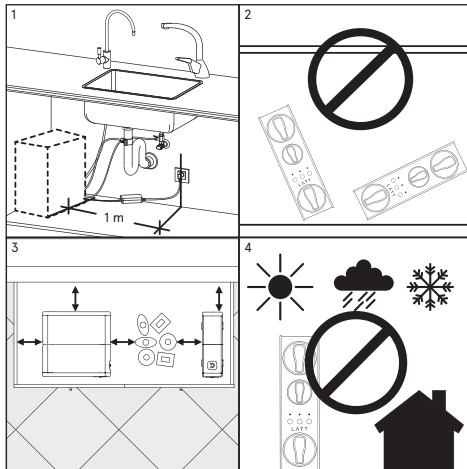

3. INSTALLING THE EQUIPMENT

- If the installation of the housing needs to be conditioned in order to be able to install the equipment in the planned location, this must be done in accordance with national standards for interior installations of water and electricity supplies.

- This equipment needs an electrical socket at a distance of less than 1 metre (1).

3.1. STARTING UP AND MAINTENANCE

! ATTENTION: Water treatment plants requires regular maintenance by qualified technical personnel in order to guarantee the quality of the water produced and supplied.

- The consumable elements must be changed at the time indicated by the manufacturer.

- The equipment must be sanitized periodically and before starting up.

- After putting it into use, discard any water that it produces during the first 30 minutes of use.

- Maintenance must be carried out by qualified technical personnel, with proper care and hygienic conditions, in order to reduce the risk of internal contamination of the appliance and its hydraulic system. (For more information contact your dealer's technical service).

4. UNPACKING

Before installation and start-up, it is important to check the box and condition of the equipment to ensure that it has not been damaged in transit.

! ATTENTION: Claims for damage during transport must be presented together with the delivery note

or invoice to your distributor, attaching the name of the carrier within a maximum of 24 hours after receipt of the goods.

Remove the equipment and accessories from their cardboard packaging, removing the corresponding protections.

! ATTENTION: Dispose of plastic bags properly and keep them out of the reach of children, as they may be dangerous to them.

Inside you will find: Water treatment equipment, installation accessories and documentation...

The materials used in the packaging are recyclable and should be disposed of in the appropriate selective collection containers or at the local centre specifically for the recovery of waste materials.

This product should not be disposed of together with normal urban waste. At the end of the useful life of the equipment, it must be delivered to the company or centre where the device was purchased, or to a specific local Clean Point or centre for the recovery of materials, indicating that it has electrical and electronic components. The correct collection and treatment of unserviceable equipment contributes to preserving natural resources and also to avoiding potential risks to public health.



5. INSTALLATION

The installation of your osmosis equipment must be carried out by a qualified staff. Read this manual first and if you have any questions, consult your dealer.

! ATTENTION: Since the appliance to be installed improves the quality of the water to be consumed, all the tools to be used for assembly and installation must be clean and under no circumstances must they be contaminated or permeated with grease, oils or oxides. Use tools exclusively for cutting tubes, handling membranes, etc. Keep them clean and disinfect them periodically.

! ATTENTION: The work must be carried out with a proper approach and hygienic conditions, taking extreme precautions in everything related to materials and components that are going to be in contact with the water to be treated or consumed.

(For more information contact your distributor).

! ATTENTION: Prevent the risks of external contamination of the equipment by handling it properly, by using gloves, hand sanitizing gel or washing hands as often as necessary throughout the installation, start-up and maintenance of the equipment.

The most common place to install the equipment is usually under the kitchen sink or in an adjacent cabinet. Install the faucet, hydraulically and electrically, to the drain collar and inlet adaptor and connect them to the respective equipment connectors (5, 6, 6.1 and 7).

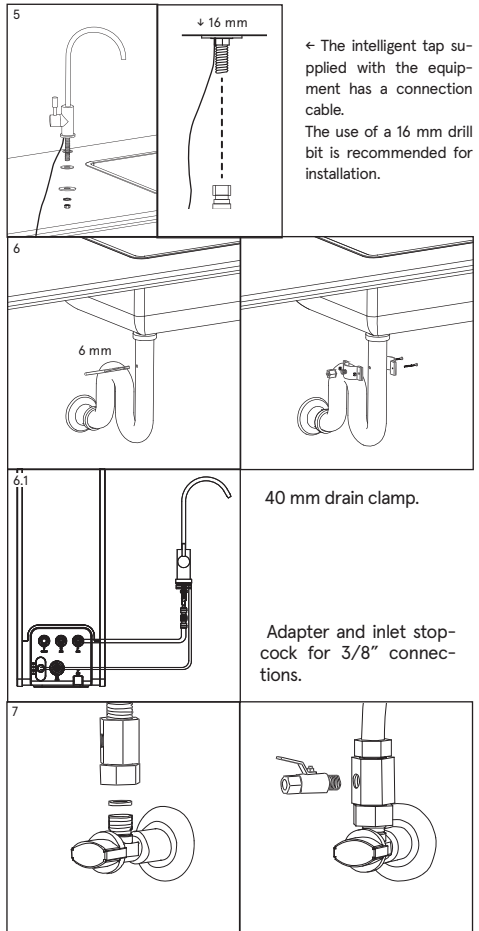

See page 13 for hydraulic diagram.

! ATTENTION: Some of the accessories for the installation may vary depending on the model and the region in which the equipment is distributed.

5.1. MIXING KIT

- If you wish to increase the pH, conductivity and chlorine concentration at the outlet, you must install according to the following diagram and using the corresponding components included in the mixing kit (consult your distributor).

- After starting up, open the tap and with the corresponding meter of the parameter of interest, measure in the water dispensed by the tap and slowly and progressively open the mixing valve until the desired parameter is achieved.

- The water dispensed must comply with the potability requirements established by European Directive 98/83 or corresponding national legislation transposing it.

5.2. INSTALLATION OF FILTERS

- Remove the rubber plugs on the pre-filter (CF), membrane (RO) and post-filter (CB) water intakes as shown in Figures 8, 9 and 10.

- Install the CF filter in the first stage of the LATT machine (lower position), the RO membrane in the second stage of the LATT machine (upper position) and the CB post-filter in the third stage of the LATT machine (middle position).

- To install the filters, present each filter in its respective housing with the handle in horizontal position, as shown in figure 11.

- Insert firmly until the end and turn the handle 90 degrees clockwise. After installation, the three filters should remain as shown in Figure 12.

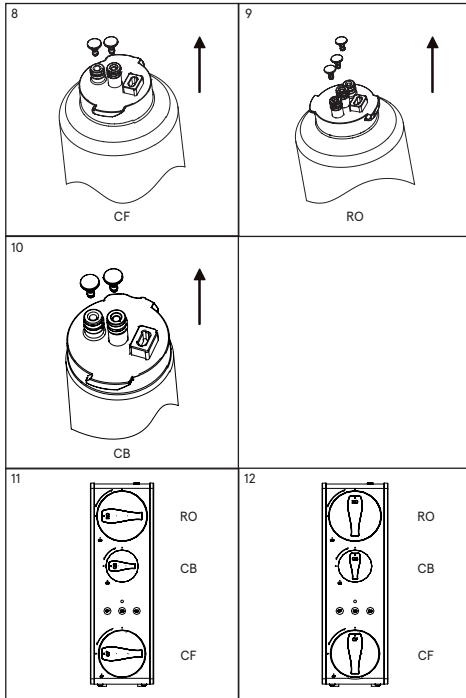

6. LAUNCHING

6.1. RINSING OF FILTER

- It is necessary to remove the dust that the carbon grain of the filter generated during transport and handling of the equipment and corresponding. This dust must be removed as it could partially or completely obstruct the membrane as well as cause a malfunction of the equipment. The equipment will automatically carry out a washing when the filters are replaced.

6.2. SANITIZATION OF THE EQUIPMENT

- Sanitize the equipment according to the model and

procedure indicated by the manufacturer (see Sanitization Procedure). If in doubt, consult your dealer.

6.3. SEALING THE SYSTEM, SHUTDOWN AND START-UP

- Close the equipment faucet on the worktop and keep

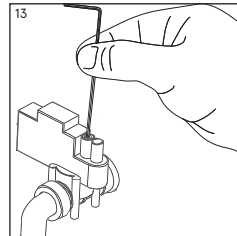

the equipment hydraulically or electrically supplied by carrying out an eye check of the system to ensure that there is no leakage (for approx.).

- If the equipment pump does not stop, adjust the tare weight of the maximum pressure switch with an Allen key 2, until the pump (13) stops.

Open the dispenser tap. The equipment should be activated and water supplied. Turn off the tap again and check that the equipment stops.

6.4. RINSING AND CLEANING

- Open the faucet and measure the quality of the water being produced. With a conductivity meter or TDS, check that the reduction in salts obtained is adequate with respect to the water to be treated (14).

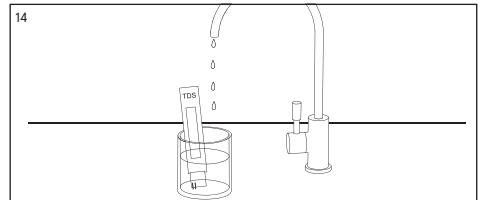

! ATTENTION: in case of detecting that the water dispensed did not comply with the national legislation currently in place, redo the measurement. If the deviation persists, close the equipment entry valve, empty it through the tap, disconnect it electrically and contact your technical service.

- Finally, clean the inside and bottom of the equipment with disposable blotting paper in order to remove any water that may have fallen into the equipment, as this could cause a false alarm and blockage of the system.

7. MAINTENANCE

! ATTENTION: Some components of your equipment, such as pre-filters and membrane, are consumables that have a limited lifespan.

The duration will depend on the quality of the local water, usage and specific characteristics of the water to be treated such as extreme turbidity, high chlorination, excess iron, etc.

! ATTENTION: In order to guarantee the quality of the water supplied by your equipment, it must be maintained regularly.

RECOMMENDED MAINTENANCE

CF prefilter: at least every 12 months. *

RO osmosis membrane: Every 2 years approx (for waters to be treated soft (hardness <15 °HF)).

Postfilter CB: At least every 12 months.

Hygienization: At start-up. At least every 12 months depending on use. Every time components in contact with water of the equipment are accessed or no water has been consumed for more than one month.

* Depending on the intended use and characteristics of the water to be treated.

Maintenance must be carried out by a qualified personnel, who must handle the equipment properly, as well as using original spare parts to maintain the characteristics, guarantee, certifications and performance of the equipment and thus preserve the quality of the water dispensed.

! ATTENTION: The use of non-original spare parts, installation outside the limits of operation and start-up, improper maintenance or use may lead to the loss of the warranty, as well as the invalidation of the certifications to which the equipment has been subjected.

Excessive use of any compound (complete chlorine, turbidity, hardness, etc...) may cause a reduction in the lifespan of filters and certain components. These maintenance are indicative.

Your distributor will foresee the duration of the consumables according to the characteristics of the water to be treated and the consumption foreseen in each case.

! ATTENTION: All consumables are supplied in individual packaging specially designed to guarantee hygienic storage and transport conditions. Use extreme caution after removing the consumables from their packaging and during handling of the various connectors and components.

! ATTENTION: Before disassembling the equipment, provide all the material you will need to carry out the maintenance operations (read section 5 Installation) and the space required for this. Work in a well-lit place, in suitable hygienic conditions and with sufficient space to carry out the operations comfortably.

- Change filters properly. Ensure the watertightness of the joints and the original hydraulic configuration of the system as recommended by the manufacturer.

- Hygienize the equipment following the instructions described in the Hygienization Procedure.

- For more information, refer to the technical data sheet of the equipment. If you have any other questions, consult your distributor.

! ATTENTION: Wear gloves or appropriate personal protective measures if you use chemicals during sanitization.

Hydraulic diagram. See page 10.

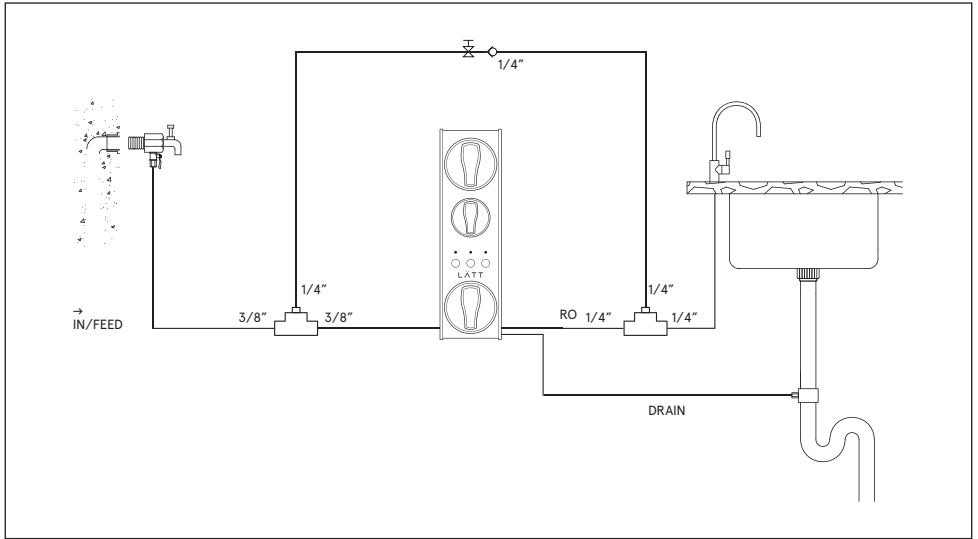

HYGIENISATION PROCEDURE

1. HYGIENISATION

Material required:

- Manual valve.
- Dosing cup and connectors.
- Hydrogen peroxide 3% (0.5 l).
- Brush.
- Single use vinyl gloves.
- Soap or detergent for easy rinsing.
- Food lubricant.
- Hydrogen peroxide detection strips.
- Sanitizing spray.
- Paper napkin.

Carry out a sanitization of the equipment during start-up, when appropriate (whenever there is a risk of contamination of the equipment by manipulation of components in contact with water) or with the periodicity indicated. To do this, follow the steps below:

! ATTENTION: The water used during sanitization must be drinking water (from a public distribution network complying with the corresponding drinking water requirements of RD 140 / 2003, European Directive 98 / 83 or local legislation in force).

- Open the tap and allow water to recirculate in order to renew the water inside the equipment.
- Close the inlet valve (1) and open the dispenser tap (2) to reduce the pressure in the equipment.

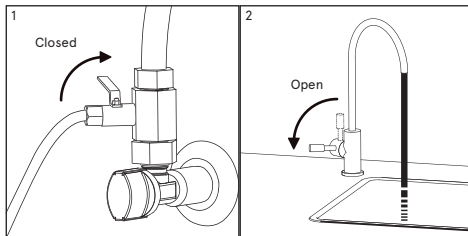

- Change the filters and wash them as indicated in the corresponding section of the Technical Manual of the equipment. Sanitization must be carried out with the new pre-filters and after-filters installed and rinsed previously in an appropriate way (correctly removed carbon dust from them).

- Use vinyl gloves of only one (3) use to handle sanitizing products.

! ATTENTION: Use extreme caution when handling filters, membrane and equipment components in contact with water. Wear disposable gloves or wash hands as often as necessary to avoid risks of equipment contamination.

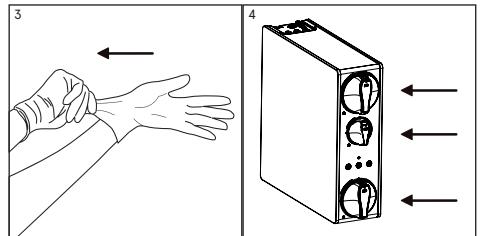

- In order to sanitize the equipment, the filters must be placed inside their housings (4).

- If you replace a deteriorated membrane or filter at the end of its useful life, remove the deteriorated membrane for disposal and clean the inside of the housing and connections with a brush (which must be kept clean and disinfected) together with soap or detergent that is easy to rinse (generates little foam) and suitable for cleaning surfaces in contact with food (5). Afterwards, rinse the housings and connectors properly, ensuring that all traces of detergent are removed.

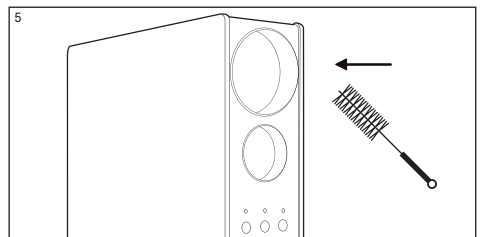

2. PRE-FILTRATION, MEMBRANE AND POST FILTRATION TREATMENT

- Disconnect the inlet pipe to the unit marked "feed-in", and insert the dosing cup between the stopcock and the water inlet of the unit (6). For greater convenience and ease of access during sanitization and during opening and closing of the input valve, you can insert, together with the sanitizing dosing cup, a manual valve in the closed position, which will perform the same functions as the manual shut-off valve at the inlet to the equipment.

- Once the unit is installed, keep the new manual inlet valve closed and open the inlet valve connected to the wall adapter (7). The measuring cup must be empty.

- Pour 0.25 litres of hydrogen peroxide into the measuring cup inserted in the equipment inlet (8). Thread the beaker correctly to its head.

- The manual inlet valve and the tap must be closed. Connect the equipment to the power supply.

- Open the water inlet tap to the equipment and to the faucet, allowing its operation to start and allowing the Hydrogen Peroxide to be sucked into it. Fill a 1L carafe with tap water. Before closing the faucet, close the inlet tap again to lower the pressure. Fill the dispenser again with 0.25l of hydrogen peroxide and empty 1 litre more of water. Turn off the tap. At this moment the whole circuit contains sanitizing liquid.

- After 10 mins. open the dispenser tap (9) and let the mains water circulate for 5 mins.

- Empty the measuring cup. Before opening it, have a container within reach where you can empty it, as it may be filled with water.

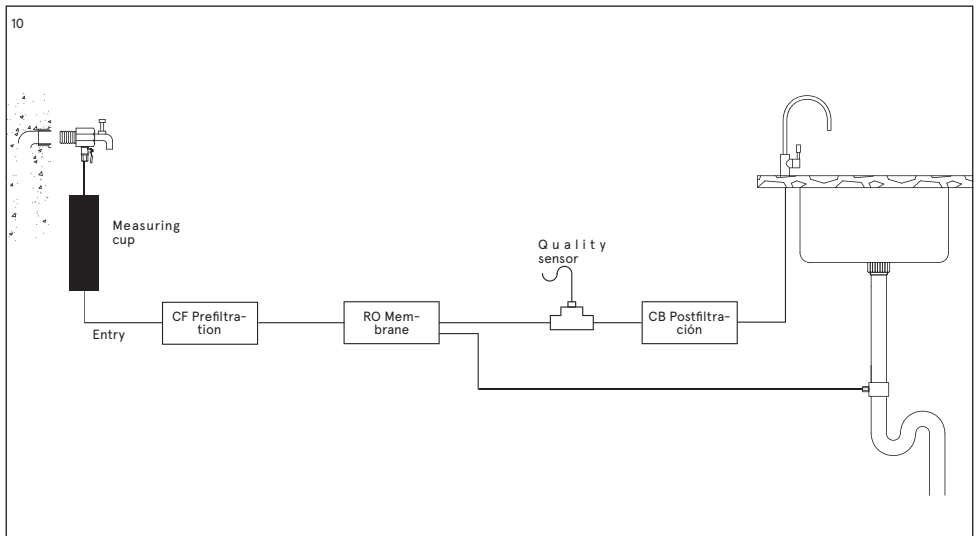
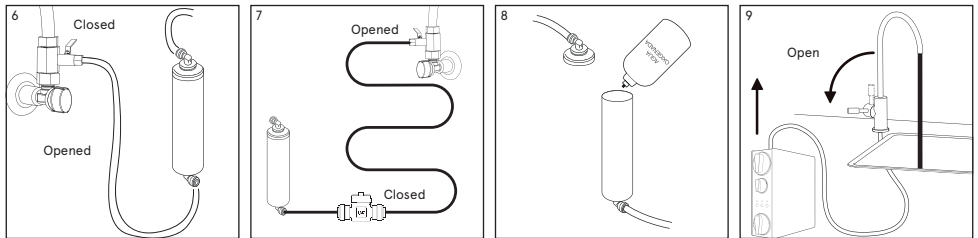

- Pay special attention to the sanitization of the tap spout. Use the sanitizing sprayer (or in its absence, hydrogen peroxide, measuring it in such a way that it penetrates the spout of the faucet) and single use drying kitchen paper. Spray the spray onto the tap nozzle (11), rub the spout and tap nozzle with the disposable paper and do not touch it directly with your hands (12).

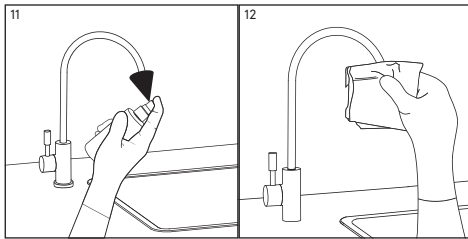

3. RINSING

- Since sanitization and rinsing do not guarantee complete removal of carbon dust from new filters or residues from sanitization, rinse the osmosis equipment with plenty of water after each sanitization, by circulating mains water of appropriate quality for 5 minutes or more. Dispose of the first 5 litres of water before consuming it.

- Rinse the pre-filter each time it is replaced and prior to each sanitization of the equipment.

- Rinse the pre-filter, preferably isolated from the rest of the equipment even before installation.

- Carry out the rinse with plenty of water that complies with local regulations regarding the parameters of potability of the water.

- Fill the pre-filter slowly in order to evacuate the contained air and avoid internal turbulences that could alter the different stages of filtration. When the water gushes through the outlet opening, the flow rate increases progressively. Extract at least 4L and make sure that this water no longer contains coal fines.

- Keep the filter in the same position during the whole process as it will be once installed in the equipment.

- At the end of the process, take a drying paper and wipe off all parts that may have gotten wet, especially the Aquastop leak detection sensor (in case the equipment has one).

TECHNICAL DATA SHEET

FOR REVERSE OSMOSIS EQUIPMENT

1. TECHNICAL FEATURES

APPLICATION

Water treatment

Reverse osmosis

Usage

Improvement of the characteristics of drinking water (complying with the requirements of the European Drinking Water Directive 98/83 or its national transpositions in the different Member States of the European Community).

Modifications by reduction or contribution

- Reverse osmosis water treatment is able to reduce concentrations of salts and other substances by high percentages.

- Minimum reduction* of certain compounds and parameters:

Sodium: 90%.

Calcium: 90%.

Sulphate: 90%.

Chloride: 90%.

Total hardness: 90%.

Conductivity: 90%.

* Depending on the characteristics of the water to be treated (at the exit of the membrane). These values may vary depending on the type of post-filter incorporated in the equipment and/or regulation of the mixing valve (if included).

OPERATIONAL LIMITS

EQUIPO CON BOMBA

Pressure (max./min.):

4 bar - 1 bar (400kPa-100kPa).

TDS (max.):

1500ppm.

Temperature (max./min.):

38 °C - 5 °C.

Hardness (max.):

15 °HF. **

Type of control:

Maximum pressure switch.
Solenoid valve for inlet control.
Solenoid flushing valve

Security system:

Minimum pressure switch.
Electronic leak sensor.
Water quality control.
Maintenance warning.

Dimensions (W x D x H in mm):

414 x 130 x 445.

Weight (in kg, including all accessories):

12,45.

Inlet connection:

3/8".

Discharge connection:

1/4".

Tap connection:

1/4".

Wall adapter:

3/8" M-F. *****

Drain collar:

Tube Clamp

40 mm drainage.

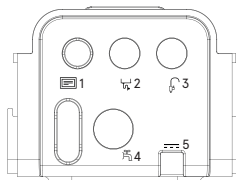
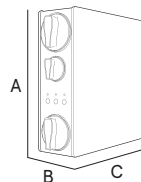

1. Data interface
2. Drainage
3. Tap
4. Entrance
5. "Power"

CF Prefilter

1 x combined sediment/carbon.



RO membrane

1 x 600 GPD membrane.

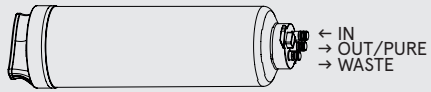

Flow rate of osmosed water: 1,8 lpm.
Volume of osmosed water: 4,000 l.
Optimum working pressure: 2bar.

CB Postfilter

1 x Postfilter carbon.

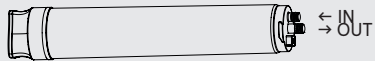

Power supply:
Electrical adapter:
Type of tap:
Production

24 VDC 5 A.
100-240 Vac 50 / 60 Hz: 24 Vdc.
Intelligent tap.
1,8 lpm.
(inlet water conditions: 450 μ S, 15 °HF, 17 °C and 3 bar)
Automatic flushing (see 3.2)

Membrane cleaning system:

HYDRAULIC DIAGRAM

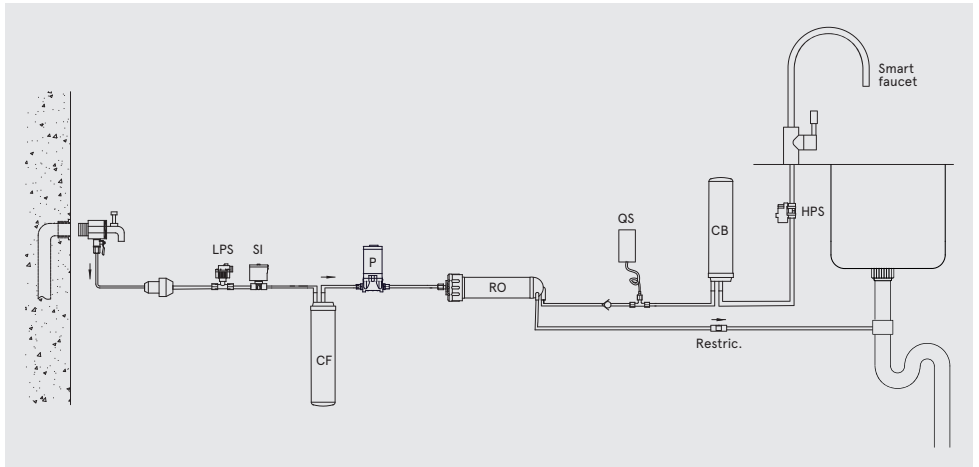

HYDRAULIC WIRING DIAGRAM

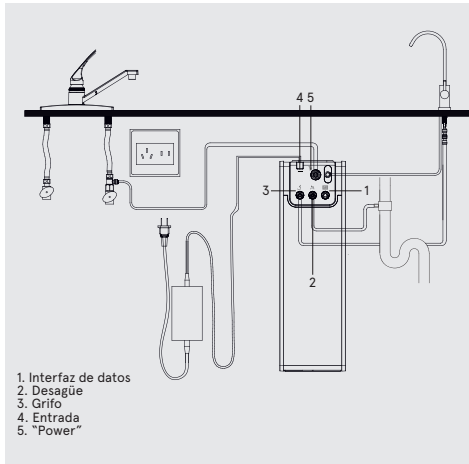

- * For salinity higher than 1500ppm consult your distributor.
- ** Higher hardnesses may shorten the life and function of certain components.
- *** Maximum accumulation as a function of inlet pressure.
- **** Flow rates may vary by 20% depending on the temperature, pressure and specific composition of the water to be treated.
- ***** May vary depending on model.

DISTRIBUIDO POR:

IONFILTER
Aiguafreda, 8
Pol. Ind. L'Ametlla Park
08480, L'Ametlla del Vallès
Barcelona - Spain
T. 902 305 310 F. +34 936 934 329

2. OPERATION OF THE EQUIPMENT

- The mains water to be treated enters the equipment through the pre-filtration stage which features a GAC (CF) turbidity and carbon filter. In this filtration stage, suspended particles, chlorine, its derivatives and other organic substances are retained.

- The unit features a minimum pressure switch to protect the pump against pressure drops in the network (LPS).

- The flow of water into the equipment is controlled by a solenoid shut-off valve (Si).

- The water, after being treated in the filtration stage, is pushed towards the reverse osmosis (RO) membrane. The equipment incorporates a pump (P) to increase the pressure. The pressure of the water on the membrane makes the reverse osmosis process possible.

- Before going out through the tap, the water passes through the post-charcoal filter, which improves the taste.

- Rejected water or water containing excess salts and other dissolved substances is directed to the drain for disposal.

- The direct flow equipment controls the start and stop by means of a pressure switch (HPS).

- The equipment incorporates different functional and/or security systems, managed by a state-of-the-art electronic module:

- Electronic leak detection system (L). When the system detects this situation, it blocks the equipment emitting an acoustic and luminous signal informing about it. The equipment will remain blocked until the detection probe is dry.

- Probe for estimating the conductivity of the water

produced to evaluate the condition of the membrane and components (Q). When water is dispensed through the tap, the system will measure the conductivity of the water produced.

- Automatic filter change warning, in order to inform the user that proper maintenance must be carried out to guarantee the quality of the water dispensed.

3. INTERFACE. STATE OF THE SYSTEM

Display

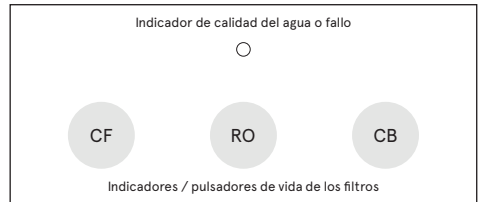

3.1 WATER QUALITY INDICATOR COLORS

- Blue: TDS ≤ 200ppm
- Lilac: 200ppm < TDS ≤ 300ppm
- Red: TDS > 300ppm

3.2. FUNCIONALIDADES

FUNCTION	ACTIONS	LIGHT STATUS
1. Cleaning for first use.	The RO membrane will be washed by the machine for 5 minutes. Afterwards, open the tap for 30 minutes.	During the wash, the water quality light is shown flashing red at 1Hz. After 6 minutes, the water quality light will return to the live measurement state.
2. Cleaning when the machine is switched on.	Whenever the system is turned on, it will wash the RO membrane for 20 seconds. If the user opens the tap, the machine will stop washing and go into normal mode.	When washing is in progress, the water quality light shows the previous on state.
3. Cleaning when running time is reached.	Each time the cumulative working time reaches 2 hours, the system will wash the membrane for 20 seconds. If the user opens the tap, the machine will stop washing and go into normal mode.	When washing is in progress, the water quality light shows the previous wash status.
4. Daily cleaning.	When the machine has been out of operation for 24 hours, the system will wash the membrane for 20 seconds. If the user opens the tap, the machine will stop washing and go into normal mode.	When washing is in progress, the water quality light shows the previous wash status.
5. Cleaning after changing filters.	<p>CF: When changing the CF prefilter and restarting its use counter, the system will start a wash of the CF filter and RO membrane for 5 minutes.</p> <p>RO: When changing the RO membrane and resetting its usage counter, it must be washed by opening the tap for 30 minutes.</p> <p>CB: When changing the CB postfilter and resetting its use counter, the filter should be washed by opening the tap for 15 minutes.</p> <p>If all filters are changed and restarted at the same time, the system will wash the CF filter and RO membrane for 5 minutes. Then open the tap for 30 minutes to wash the CB postfilter.</p>	<p>When the RO membrane is being washed, the water quality light is shown in red and will flash at 1Hz.</p> <p>When any other filter is washed, the water quality light displays real-time water quality data and flashes at 1Hz.</p>
6. Opening of tap.	The system is put into normal operation.	<p>For the first 30 seconds, the water quality light shows the latest quality status and is always on.</p> <p>For the next 30 seconds, the water quality light displays real-time quality data and is always on.</p>
7. Closing the tap.	The system stops producing water and is put on standby.	The water quality light turns off.
8. Switching on the system.	The system starts.	After the power is turned on, a beep sounds and all the lights turn on and off at the same time, changing from blue to lilac to red. Each color is displayed for 1 second.

3.3. IDENTIFICATION AND RECTIFICATION OF FAULTS

TYPE	NOTIFIER		SOLUTION
	DISPLAY	ACOUSTICS	
1. Lack of water pressure at the inlet.	Fault-light in red, CF light in blue.	3 beeps.	When the water pressure at the inlet returns, the system also returns to its normal state, and the alarm is turned off.
2. Leakage inside the machine.	Fault-light in red, uz RO in blue.	Beeps for 3 minutes.	When the leak is repaired, the alarm is deactivated and the system returns to its normal state.
3. Pump time protection.	Fault-light in red, CB light in blue.	4 beeps.	Since then the pump has been working between 30 and 33 minutes. Disconnect and reconnect the electrical connection.
4. Pump start/stop protection.	Fault-light in red, CF and RO light in blue.	5 beeps.	Disconnect and reconnect the electrical connection.
5. Low temperature protection.	Fault-light in red, CB and RO light in blue.	6 beeps.	Disconnect and reconnect the electrical connection.
When you detect that the unit is in one of the states listed above, contact the maintenance service to make an appointment to perform the required maintenance.	after several hours of continuous operation, without water extraction.	or showing any type of alarm.	Contact your service technician to reset the counters after changing filters.
See the corresponding section in the technical manual.	Contact your technical service if the equipment is repeatedly blocked due to a lack of mains water pressure at the inlet and there is pressure in the rest of the dwelling.		
Contact your technical service if the equipment does not stop running (filling the tank)	Contact your technical service if after opening the faucet the equipment is at rest without dispensing water through the faucet		

3.4. LIFETIME DISPLAY OF THE FILTERS

LIFESPAN	LIFE REMAINING (DAYS)	CAPACITY OF REMAINING LITRES	NOTIFIER	
			DISPLAY	ACOUSTICS
Normal.	> 15	> 150	Permanent blue.	No alarm.
There is little left.	$0 < X \leq 15$	$0 < Y \leq 150$	Permanent lilac.	Double beep when filter life is short.
Exhausted.	≤ 0	≤ 0	Permanent red.	Beeps when water is dispensed.

3.5. MANUAL WASHING MODE

Press the three buttons CF, RO and CB simultaneously for 3 seconds to activate the manual wash mode. After a beep, the system washes the CF filter and RO membrane for 5 minutes. If during these 5 minutes the three buttons are pressed again at the same time for 3 seconds or if the tap is opened, the system will automatically return to normal mode.

4. WARRANTY

The distributor guarantees the equipment for a period of two years in the event of any non-compliance detected in the equipment, in accordance with Royal Decree 1/2007 of 16 November (revised text of the General Law for the Defence of Consumers and Users).

- The guarantee includes the repair and replacement of faulty parts by personnel authorised by the distributor or by the official technical assistance service (S.A.T.) at the place of installation or in its workshops. Included in the warranty is labor and shipping costs that may be generated.
- The distributor is exonerated from providing a guarantee in the case of parts subject to natural wear, lack of maintenance, blows or other nonconformities resulting from improper use of the equipment or inadequate according to the conditions and operating limits indicated by the manufacturer of the same. Likewise, the warranty becomes ineffective in cases of improper handling and use of the equipment or in those cases in which they have been modified or repaired by personnel outside the distribution company or official S.A.T..
- The parts replaced under warranty will remain the property of the distributor.
- The distributor is responsible for the lack of conformity of the equipment when it refers to the origin, identity or suitability of the products, according to their nature and purpose. Bearing in mind the characteristics of the equipment it is essential for the warranty to cover the lack of conformity, the fulfillment of the technical conditions of installation and operation. Failure to comply with these conditions may result in the absence of a warranty, taking into account the relevance of the destination of the equipment and the conditions and operating limits in which it must operate.
- The distributor must ensure that the installed equipment is suitable for improving the quality of the water to be treated in particular, according to the characteristics of the equipment and the regulations in force.
- The distributor must ensure the correct installation and start-up of the equipment as indicated by the manufacturer and current regulations and will also be liable for any lack of conformity resulting from incorrect application, installation or start-up of the equipment.
- For any warranty claim it is necessary to present the purchase invoice. The period of two years is calculated from the purchase of the equipment from the distributor.
- If there is a problem with your equipment during the warranty period, please contact your dealer.

The equipment is installed and operating to the customer's satisfaction and for the record:

* Pre-treatment of the equipment:

* Hardness of entry to the equipment (°F):

* TDS input to the equipment (ppm):

* TDS produced water (ppm):

* Pressure of entry to the equipment (bar):

*Result of the installation and commissioning sheet:

Correct:

Others:

The owner of the equipment has been properly and clearly informed of the use, handling and maintenance that the equipment requires to ensure its proper functioning and the quality of the water produced. A maintenance contract is offered for this purpose.

*Ref: Maintenance contract:

ACCEPTS the maintenance contract

DOES NOT ACCEPT the maintenance contract

If you need information, report a malfunction or malfunction, request for maintenance or intervention by a technician, please read the operation, troubleshooting and troubleshooting sections of this manual beforehand and contact the distributor or company that sold you your equipment.

COMPANY AND/OR AUTHORIZED INSTALLER, DATE AND SIGNATURE:

SERIAL NUMBER:



NOTE TO THE COMPANY AND/OR AUTHORIZED TECHNICIAN/INSTALLER: the data marked with the * symbol must be filled in by the installer and transcribed by him/herself from the INSTALLATION REGISTRATION sheet.



5. INSTALLATION REGISTER SHEET



NOTES TO THE TECHNICIAN/INSTALLER: read this manual carefully. If in doubt, contact your dealer's Technical Support Service (T.A.S.). The data marked with the symbol * must be filled in by the technician/installer and transcribed by him/herself to the WARRANTY page. This sheet must be kept by the installer and may be requested by the distributor in order to improve after-sales service and customer service. The technician who performs the installation and commissioning of the equipment must have adequate technical training.

INFORMATION ON THE USE OF THE EQUIPMENT:

Origin of the water to be treated:

PUBLIC SUPPLY NETWORK

OTHER _____

* Pre-treatment of the equipment: _____

* Hardness of entry to the equipment (°F): _____

* TDS of entry to the equipment (ppm): _____

* TDS produced water (ppm): _____

Inlet pressure to the equipment (bar): _____

INSTALLATION STEP CONTROL:

Pre-filter assembly: _____

Overflow installation: _____

Start-up according to protocol: _____

Checking of fittings: _____

Measurement of inlet hardness: _____

Output hardness measurement: _____

Installation of isolation by-pass: _____

Correct drainage installation: _____

Brine suction test/tank filling: _____

Leakage of the pressurised system: _____

Programming of the equipment: _____

Adjustment of residual hardness: _____

COMMENTS

* Result of installation and commissioning:

CORRECT (equipment installed and working correctly. Produced water suitable for the application).

OTHER: _____

IDENTIFICATION OF THE AUTHORISED TECHNICIAN/INSTALLER: CONFORMITY OF THE OWNER OF THE EQUIPMENT:

COMPANY AND/OR AUTHORIZED INSTALLER, DATE AND SIGNATURE:

I have been clearly informed of the use, operation and maintenance required by the installed equipment, having been offered a maintenance contract and informed of how to contact a customer service in the event of a request for information, communication of a breakdown or malfunction, request for maintenance or intervention by a technician.

Remarks: _____

*Ref: Maintenance contract: _____

ACCEPTS the maintenance contract

DOES NOT ACCEPT the maintenance contract

Model/Ref: _____

Owner: _____

Street _____

Telephone: _____

City: _____

Province: _____

C.P.: _____

SERIAL NUMBER

EQUIPMENT WARRANTY DIRECTED TO THE DISTRIBUTOR:

The distributor will only be responsible for the replacement of parts in the event of non-conformity. The repair of the equipment and the costs involved (labour, shipping costs, travel, etc.) will be borne by the distributor, in accordance with the general conditions of contract and sale, so it can not be passed on later to the manufacturer.



6. MAINTENANCE SERVICE

DATE	SERVICE TYPE	NAME, SIGNATURE AND STAMP OF THE AUTHORISED TECHNICIAN	
<input type="text"/>	<input type="radio"/> SETTING UP		
<input type="text"/>	<input type="radio"/> FULL MAINTENANCE	TECHNICIAN <input type="text"/>	<input type="radio"/> ORDINARY <input type="radio"/> OUTSTANDING. <input type="radio"/> WARRANTY
<input type="text"/>	<input type="radio"/> PREPARATION	STAMP	
<input type="text"/>	<input type="radio"/> HYGIENISATION	<input type="text"/>	
<input type="text"/>	<input type="radio"/> OTHER		
<input type="text"/>	<input type="radio"/> FULL MAINTENANCE	TECHNICIAN <input type="text"/>	<input type="radio"/> ORDINARY <input type="radio"/> OUTSTANDING. <input type="radio"/> WARRANTY
<input type="text"/>	<input type="radio"/> PREPARATION	STAMP	
<input type="text"/>	<input type="radio"/> HYGIENISATION	<input type="text"/>	
<input type="text"/>	<input type="radio"/> OTHER		
<input type="text"/>	<input type="radio"/> FULL MAINTENANCE	TECHNICIAN <input type="text"/>	<input type="radio"/> ORDINARY <input type="radio"/> OUTSTANDING. <input type="radio"/> WARRANTY
<input type="text"/>	<input type="radio"/> PREPARATION	STAMP	
<input type="text"/>	<input type="radio"/> HYGIENISATION	<input type="text"/>	
<input type="text"/>	<input type="radio"/> OTHER		
<input type="text"/>	<input type="radio"/> FULL MAINTENANCE	TECHNICIAN <input type="text"/>	<input type="radio"/> ORDINARIA <input type="radio"/> EXTRAORDINARIA <input type="radio"/> GARANTÍA
<input type="text"/>	<input type="radio"/> PREPARATION	STAMP	
<input type="text"/>	<input type="radio"/> HYGIENISATION	<input type="text"/>	
<input type="text"/>	<input type="radio"/> OTHER		
<input type="text"/>	<input type="radio"/> FULL MAINTENANCE	TECHNICIAN <input type="text"/>	<input type="radio"/> ORDINARY <input type="radio"/> OUTSTANDING. <input type="radio"/> WARRANTY
<input type="text"/>	<input type="radio"/> PREPARATION	STAMP	
<input type="text"/>	<input type="radio"/> HYGIENISATION	<input type="text"/>	
<input type="text"/>	<input type="radio"/> OTHER		

6. MAINTENANCE SERVICE

DATE	SERVICE TYPE	NAME, SIGNATURE AND STAMP OF THE AUTHORISED TECHNICIAN	
<input type="text"/>	<input type="radio"/> SETTING UP		
<input type="text"/>	<input type="radio"/> FULL MAINTENANCE	TECHNICIAN <input type="text"/>	<input type="radio"/> ORDINARY <input type="radio"/> OUTSTANDING. <input type="radio"/> WARRANTY
<input type="text"/>	<input type="radio"/> PREPARATION	STAMP	
<input type="text"/>	<input type="radio"/> HYGIENISATION	<input type="text"/>	
<input type="text"/>	<input type="radio"/> OTHER		
<input type="text"/>			
<input type="text"/>	<input type="radio"/> FULL MAINTENANCE	TECHNICIAN <input type="text"/>	<input type="radio"/> ORDINARY <input type="radio"/> OUTSTANDING. <input type="radio"/> WARRANTY
<input type="text"/>	<input type="radio"/> PREPARATION	STAMP	
<input type="text"/>	<input type="radio"/> HYGIENISATION	<input type="text"/>	
<input type="text"/>	<input type="radio"/> OTHER		
<input type="text"/>			
<input type="text"/>	<input type="radio"/> FULL MAINTENANCE	TECHNICIAN <input type="text"/>	<input type="radio"/> ORDINARY <input type="radio"/> OUTSTANDING. <input type="radio"/> WARRANTY
<input type="text"/>	<input type="radio"/> PREPARATION	STAMP	
<input type="text"/>	<input type="radio"/> HYGIENISATION	<input type="text"/>	
<input type="text"/>	<input type="radio"/> OTHER		
<input type="text"/>			
<input type="text"/>	<input type="radio"/> FULL MAINTENANCE	TECHNICIAN <input type="text"/>	<input type="radio"/> ORDINARY <input type="radio"/> OUTSTANDING. <input type="radio"/> WARRANTY
<input type="text"/>	<input type="radio"/> PREPARATION	STAMP	
<input type="text"/>	<input type="radio"/> HYGIENISATION	<input type="text"/>	
<input type="text"/>	<input type="radio"/> OTHER		
<input type="text"/>			
<input type="text"/>	<input type="radio"/> FULL MAINTENANCE	TECHNICIAN <input type="text"/>	<input type="radio"/> ORDINARY <input type="radio"/> OUTSTANDING. <input type="radio"/> WARRANTY
<input type="text"/>	<input type="radio"/> PREPARATION	STAMP	
<input type="text"/>	<input type="radio"/> HYGIENISATION	<input type="text"/>	
<input type="text"/>	<input type="radio"/> OTHER		
<input type="text"/>			



6. MAINTENANCE SERVICE

DATE	SERVICE TYPE	NAME, SIGNATURE AND STAMP OF THE AUTHORISED TECHNICIAN	
<input type="text"/>	<input type="radio"/> SETTING UP		
<input type="text"/>	<input type="radio"/> FULL MAINTENANCE	TECHNICIAN <input type="text"/>	
<input type="text"/>	<input type="radio"/> PREPARATION	STAMP	<input type="radio"/> ORDINARY
<input type="text"/>	<input type="radio"/> HYGIENISATION	<input type="text"/>	<input type="radio"/> OUTSTANDING.
<input type="text"/>	<input type="radio"/> OTHER	<input type="text"/>	<input type="radio"/> WARRANTY
<input type="text"/>	<input type="radio"/> FULL MAINTENANCE	TECHNICIAN <input type="text"/>	
<input type="text"/>	<input type="radio"/> PREPARATION	STAMP	<input type="radio"/> ORDINARY
<input type="text"/>	<input type="radio"/> HYGIENISATION	<input type="text"/>	<input type="radio"/> OUTSTANDING.
<input type="text"/>	<input type="radio"/> OTHER	<input type="text"/>	<input type="radio"/> WARRANTY
<input type="text"/>	<input type="radio"/> FULL MAINTENANCE	TECHNICIAN <input type="text"/>	
<input type="text"/>	<input type="radio"/> PREPARATION	STAMP	<input type="radio"/> ORDINARY
<input type="text"/>	<input type="radio"/> HYGIENISATION	<input type="text"/>	<input type="radio"/> OUTSTANDING.
<input type="text"/>	<input type="radio"/> OTHER	<input type="text"/>	<input type="radio"/> WARRANTY
<input type="text"/>	<input type="radio"/> FULL MAINTENANCE	TECHNICIAN <input type="text"/>	
<input type="text"/>	<input type="radio"/> PREPARATION	STAMP	<input type="radio"/> ORDINARIA
<input type="text"/>	<input type="radio"/> HYGIENISATION	<input type="text"/>	<input type="radio"/> EXTRAORDINARIA
<input type="text"/>	<input type="radio"/> OTHER	<input type="text"/>	<input type="radio"/> GARANTÍA
<input type="text"/>	<input type="radio"/> FULL MAINTENANCE	TECHNICIAN <input type="text"/>	
<input type="text"/>	<input type="radio"/> PREPARATION	STAMP	<input type="radio"/> ORDINARY
<input type="text"/>	<input type="radio"/> HYGIENISATION	<input type="text"/>	<input type="radio"/> OUTSTANDING.
<input type="text"/>	<input type="radio"/> OTHER	<input type="text"/>	<input type="radio"/> WARRANTY

6. MAINTENANCE SERVICE

DATE	SERVICE TYPE	NAME, SIGNATURE AND STAMP OF THE AUTHORISED TECHNICIAN	
<input type="text"/>	<input type="radio"/> SETTING UP		
<input type="text"/>	<input type="radio"/> FULL MAINTENANCE	TECHNICIAN <input type="text"/>	
<input type="text"/>	<input type="radio"/> PREPARATION	STAMP	<input type="radio"/> ORDINARY
<input type="text"/>	<input type="radio"/> HYGIENISATION	<input type="text"/>	<input type="radio"/> OUTSTANDING.
<input type="text"/>	<input type="radio"/> OTHER	<input type="text"/>	<input type="radio"/> WARRANTY
<input type="text"/>	<input type="radio"/> FULL MAINTENANCE	TECHNICIAN <input type="text"/>	
<input type="text"/>	<input type="radio"/> PREPARATION	STAMP	<input type="radio"/> ORDINARY
<input type="text"/>	<input type="radio"/> HYGIENISATION	<input type="text"/>	<input type="radio"/> OUTSTANDING.
<input type="text"/>	<input type="radio"/> OTHER	<input type="text"/>	<input type="radio"/> WARRANTY
<input type="text"/>	<input type="radio"/> FULL MAINTENANCE	TECHNICIAN <input type="text"/>	
<input type="text"/>	<input type="radio"/> PREPARATION	STAMP	<input type="radio"/> ORDINARY
<input type="text"/>	<input type="radio"/> HYGIENISATION	<input type="text"/>	<input type="radio"/> OUTSTANDING.
<input type="text"/>	<input type="radio"/> OTHER	<input type="text"/>	<input type="radio"/> WARRANTY
<input type="text"/>	<input type="radio"/> FULL MAINTENANCE	TECHNICIAN <input type="text"/>	
<input type="text"/>	<input type="radio"/> PREPARATION	STAMP	<input type="radio"/> ORDINARY
<input type="text"/>	<input type="radio"/> HYGIENISATION	<input type="text"/>	<input type="radio"/> OUTSTANDING.
<input type="text"/>	<input type="radio"/> OTHER	<input type="text"/>	<input type="radio"/> WARRANTY
<input type="text"/>	<input type="radio"/> FULL MAINTENANCE	TECHNICIAN <input type="text"/>	
<input type="text"/>	<input type="radio"/> PREPARATION	STAMP	<input type="radio"/> ORDINARY
<input type="text"/>	<input type="radio"/> HYGIENISATION	<input type="text"/>	<input type="radio"/> OUTSTANDING.
<input type="text"/>	<input type="radio"/> OTHER	<input type="text"/>	<input type="radio"/> WARRANTY

NOTES

NOTES
