



ADVANCED REVERSE OSMOSIS SYSTEM DIRECT FLOW

MANUAL

EQUIPMENT REVERSE OSMOSIS

ADVANCED REVERSE OSMOSIS SYSTEM DIRECT FLOW

ÍNDICE	P
1	User manual 4
2	Technical manual 8
3	Sanitization manual 14
4	Data sheet 19

USER MANUAL

FOR REVERSE OSMOSIS EQUIPMENT

0. MAIN FEATURES



CLICK

QUICK CONNECTIONS
AND MAXIMUM SECURITY

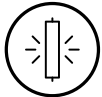

FILTER CONTROL

AUTOMATIC WARNING
OF MAINTENANCE



SOLENOID VALVE

IMMEDIATE CONTROL
SECURITY MESH



AQUASTOP

AUTOMATIC SYSTEM
LEAK DETECTION



DIRECT FLOW

PRODUCTION DIRECT
OSMOTIC WATER



LED STATUS

STATUS
INDICATIONS



HIGH PERFORMANCE MOTOR

HIGH PERFORMANCE
MOTOR



**BLOCKING
FOR SECURITY**
TO GUARANTEE
WATER QUALITY

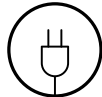

ELECTRONIC ADAPTER

GREATER SECURITY
AND EFFICIENCY



DOUBLE FLOW

HIGHER FLOW
OF WATER DISPENSED



DIRECT ACCESS

EASE OF ACCESS
AND MAINTENANCE



QUALITY CONTROL

CONDUCTIVITY
CONTROL

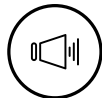

SOUND WARNINGS

OUND
WARNINGS



PRESSURE CONTROL

PROTECTION AGAINST
PRESSURE LOSS



HIGH EFFICIENCY

RECOVERY
IN THE PRODUCTION

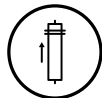

EXCLUSIVE MEMBRANE

ORIGINAL
MEMBRANE



Keep this manual, which includes the service book and warranty sections, in order to provide you with better after-sales service.

1. INTRODUCTION

Congratulations. You have purchased an excellent piece of equipment for domestic water treatment.

This unit will help you improve the features of your water.

2. WHAT IS OSMOSIS?

Natural or direct osmosis is the most common in nature, since semi-permeable membranes are part of the vast majority of organisms (for example, plant roots, organs of our own body, cell membranes, etc...)

When two solutions of different concentration of salts are separated by a semi-permeable membrane, a flow of water naturally occurs. Water from the solution of lower concentration to the solution of higher concentration. This flow continues until the concentrations on both sides of the membrane are equal.

When it comes to investing this process and achieve a flow of water with a lower concentration of salts from one with a higher concentration, a sufficient pressure of the higher concentration water must be exerted on the membrane, to overcome the tendency and natural flow of the system. This process is what we call Inverse osmosis. Currently, reverse osmosis is one of the best methods to improve the characteristics of water, through a physical system (without the use of chemical products).

The water to be purified exerts pressure on the semi-permeable membrane, so that part of it will manage to cross the pores of the membrane (osmotized water), while the rest of the water (rejected or with a high concentration of salts) will be diverted towards the drain (Fig. 1).

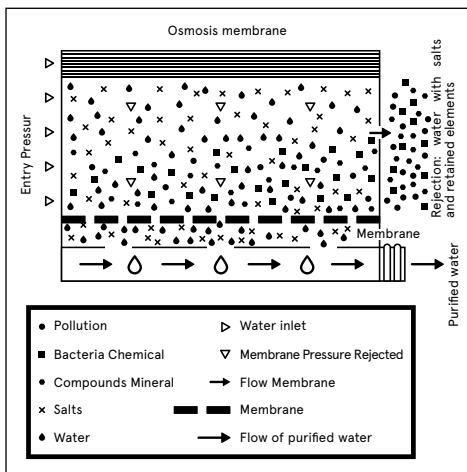

3. ADVANCE WARNINGS

! **ATTENTION:** Read carefully the warnings described in the corresponding section of the Technical Manual.

! **ATTENTION:** These equipments ARE NOT POTABILIZERS of water in the event that the water to be treated comes from a public supply (and therefore complies with current legislation), these equipments will substantially improve water quality

Water treatment equipment needs periodic maintenance carried out by qualified technical personnel, in order to guarantee the quality of the water produced and supplied.

3.1. USE OF THE EQUIPMENT

· When you are going to be away for more than a week, close the water inlet tap to the equipment, empty it and disconnect it from the power supply (PUMP model). When you return, connect the power supply to it, open the inlet valve and the tap. Let the water run out for at least 5 minutes before consuming water.

! **ATTENTION:** After a prolonged period (more than a month) in which the equipment has been found without working or producing water, contact your distributor in order to carry out a sanitization. **Properties and maintenance.**

· Extract full jugs or bottles and avoid the occasional extraction of glasses to improve the performance of the equipment.

! **ATTENTION:** Special attention must be paid to the cleaning and hygiene of the osmosis faucet, on a regular basis and especially when carrying out periodic maintenance and hygiene. To do this, use the sanitizing spray and single-use disposable kitchen paper. In no case should a cloth be used to dry hands or tap.

· This appliance can be used by children aged from 8 years and above and persons with reduced physical, sensory or mental capabilities or lack of experience and knowledge if they have been given supervision or instruction about using the appliance safely and understand the hazards involved. Children must not play with the appliance. Cleaning and user maintenance should not be performed by children without supervision.

3.2. RECOMMENDATIONS FOR THE CORRECT USE OF THE DESALINATED WATER

· If you wish to supply osmotized water to any other point of consumption (such as a refrigerator with an ice cube dispenser, another tap, etc...), the channeling should not be made with a metal tube, since this would give the water a bad taste. Always use plastic tubing.

! **ATTENTION:** The water provided by domestic osmosis equipment is of LOW MINERALIZATION. The mineral salts that the body needs

are mainly provided by food, especially dairy products and to a lesser extent by drinking water.

· It is recommended not to use aluminum utensils to cook with osmosis water.

4. BASIC OPERATION

The mains water to be treated enters the equipment passing through a sediment filter and a combined polypropylene and carbon block filter. In this filtration stage, suspended particles, chlorine, its derivatives and other organic substances are retained.

The passage of water into the equipment is controlled by a cut-off solenoid valve.

The water, after being treated in the filtration stage, is pushed towards the reverse osmosis membranes. The equipment incorporates a pump to increase the pressure, since the pressure of the water on the membrane makes the reverse osmosis process possible.

The osmosis water comes out of the equipment passing through a granulated carbon post-filter and then to the tap. Rejected water or water with excess salts and other dissolved substances is directed to the drain for disposal.

When water is no longer requested through the tap, the equipment stops its operation by means of a maximum pressure switch.

This equipment incorporates a minimum pressure switch a safety system, which protects the pump from pressure loss, stopping the equipment and preventing it from running dry.

5. USER INTERFACE

! *ATTENTION: This equipment incorporates an electronic controller that will efficiently manage its functionality and indicating the status in which it is in, as well as the different security systems.*

The equipment's technical sheet describes the states in which the system can be found and the information provided by it (pages 20-22 of this manual).

6. MAINTENANCE

In order to guarantee the quality of the water supplied by your equipment, periodic maintenance must be carried out.

Read the corresponding section of the Technical Manual to see the recommended maintenance frequency (p.11 of this manual).

7. IDENTIFICATION AND RESOLUTION OF PROBLEMS

ISSUE	POSSIBLE CAUSE	SOLUTION
1. Leaking from the outside of the unit.	Several possible	Call technical service
2. No Production.	<ol style="list-style-type: none"> 1. There is no water supply. 2. No power supply. 3. Leak sensor activated. 	<ol style="list-style-type: none"> 1. Wait for the supply to return. 2. Check the electrical supply of the house. If the problem is not solved, call the technical service. 3. Leak sensor activated. When leak detected, dry the base of the device together with the leak sensor. If it happens again, call the technical service.
3. Limited Production.	<ol style="list-style-type: none"> 1. Partially closed or obstructed inlet valve. 2. Filters / membrane in poor condition or exhausted. 	<ol style="list-style-type: none"> 1. Open it fully. 2. Call technical support.
4. Excessive Production.	Several possible causes.	Call technical support.
5. Unpleasant taste and odour.	Several possible	Call servicetechnical.
6. Whitish colour of water.	Air in the system. Microbubbles of air that disappear after a few seconds.	It is not a problem. The aspect will disappear as the air inside the equipment is eliminated.
7. Continuous dripping noise in drain.	Several possible	Call servicetechnical.
8. The unit does not start up.	<ol style="list-style-type: none"> 1. There is no water supply. 2. No electric supply. 3. Leak sensor activated. 4. Security lock. 	<ol style="list-style-type: none"> 1. Check the status of the of the equipment. 2. Check the general power supply. If the problem is not solved, call the technical service. 3. If a leak is not detected, dry the bottom of the equipment together with the leak sensor. 4. Call technical service.
9. The unit stops and starts constantly.	Several possible causes.	Call servicetechnical.
10. The equipment never stops rejecting water towards the drain.	<ol style="list-style-type: none"> 1. Inlet solenoid valve damaged. 2. Production check valve damaged. 	<ol style="list-style-type: none"> 1. Checkand replace. 2. Checkand replace.

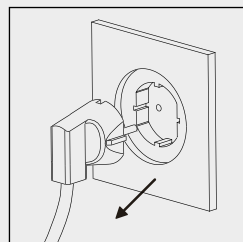
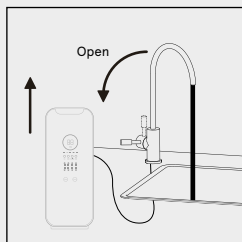
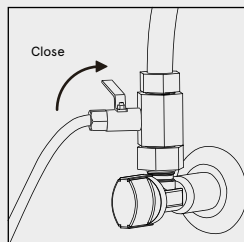

Read the INTERFACE section of the Technical Sheet. In the event of an anomaly, contact the TAS and proceed as indicated: Close the inlet valve. Open the tap to depressurize the system and pull out the plug.

TECHNICAL MANUAL

FOR REVERSE OSMOSIS EQUIPMENT

1. MAIN FEATURES

APP

Water treatment

Inverse osmosis

Use

Improvement of the characteristics of drinking water (that complies with the requirements of the European Directive on water of human consumption 98/83 or its national transpositions in the different member states of the European Community).

Modifications due to reduction or contribution

- Reverse osmosis water treatment is capable of reducing concentrations of salts and other substances in high percentages.
- Minimum reduction* of certain compounds and parameters:

Sodium: 90%.
Calcium: 90%.
Sulfate: 90%.
Chloride: 90%.
Total hardness: 90%.
Conductivity: 90%.

* Depending on the characteristics of the water to be treated (at the membrane outlet). These values can vary in depending on the type of post-filter that the equipment incorporates and/or regulation of the mixing valve (if it incorporates).

OPERATING LIMITS

	EQUIPMENT WITH PUMP
Pressure (max/min): TDS	4 bar - 1 bar (400kPa-100kPa).
(max):	1500ppm.
Temperature(max/min):	38°C - 5°C.
Hardness (max):	15°HF. **

! **ATTENTION:** *If you have any questions about the installation, use or maintenance of this equipment, contact the technical assistance service (SAT) of your distributor.*

2. ADVANCE WARNINGS

! **ATTENTION:** *the equipments ARE NOT POTABILIZERS of water. In the event that the water to be treated comes from a public supply (and therefore complies with current legislation), this equipment will substantially improve the quality of the water.*

! **ATTENTION:** *In the event that the water to be treated does not come from a public supply network or is of unknown origin, it will be necessary to carry out a physical-chemical and bacteriological analysis of the water to ensure its correct purification by applying the techniques and equipment appropriate to each need, PRIOR TO THE INSTALLATION of the equipment. Contact your dealer in order to*

to advise you on the most appropriate treatment for your case.

2.1 CONDITIONS FOR CORRECT FUNCTIONING OF THE UNIT

- The equipment should not be supplied with hot water (T>38°C).
- The ambient temperature must be between 4° and 45°C.
- For water with salinities greater than 1500 ppm, consult your distributor.

- It is recommended that the water to be treated be softened or with a maximum hardness of 15 °HF in order to obtain optimal performance of the equipment.

- In the event that the water to be treated has a hardness greater than 15 °HF, a reduction in the life of the membrane and in the performance of the equipment could occur.

- In the event that the supply water contains a concentration greater than 1.2 ppm of total chlorine, the installation of an active carbon dechlorinator filter is recommended to reduce the concentration of chlorine in the water and thus protect and lengthen the life of the equipment components.

In case the water to be treated contain:

High concentrations of iron and man-gain (Greater than 1ppm measured in the rejection of the machine).

Prolonged hyperchlorination over time. Sludge or turbidity greater than 3 NTUs.

A nitrate concentration greater than 100 ppm.

A concentration of sulfates greater than 250 ppm.

- Contact your distributor to recommend the most appropriate pretreatment for your case, and thus ensure the correct operation of the equipment, avoid damage to components and guarantee the quality of the water supplied.

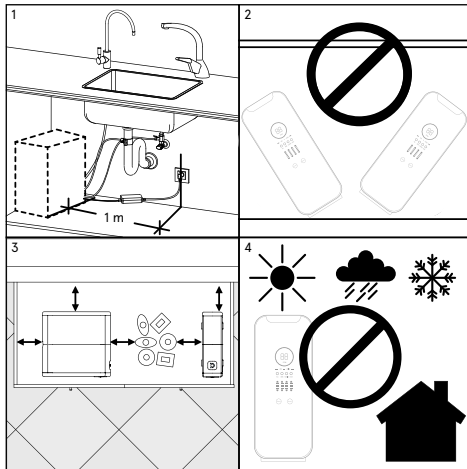

3. EQUIPMENT INSTALLATION

- In case you have to condition the installation of the dwelling to be able to install the equipment in the foreseen place, must be carried out following the national standards for interior installations of water and electrical supplies.

- These devices require an electrical outlet less than 1 meter away (1).

- This equipment must not be installed lying down or tilted (2), because the leak sensor would be disabled.

Equipment filled with water weighs more, the distribution of weights in an abnormal position could cause the any connection element is forced, which may cause a malfunction, damage to equipment components or loss of water.

- The intended place for its installation, it must have enough space for the appliance itself, its accessories, connections and for carrying out convenient maintenance (3).

- Under no circumstances should the equipment be installed outdoors. (4).

- The place and environment where the equipment and tap are installed must maintain adequate hygienic-sanitary conditions.

- The appliance must only be used with the power supply supplied with the appliance.

- The appliance must only be powered by a very low safety voltage.

- Avoid external drips on the equipment, coming from pipes, drains, etc.

! **ATTENTION: The equipment must not be installed next to a heat source or directly receiving a flow of hot air on them (dryer, refrigerator, etc).**

- New tube sets supplied with the appliance must be used and old tube sets must not be reused.

3.1. COMMISSIONING AND MAINTENANCE

! **ATTENTION: This water treatment equipment needs periodic maintenance to be carried out by qualified technical personnel, in order to guarantee the quality of the water produced and dispensed.**

- The consumable elements must be replaced with the frequency indicated by the manufacturer.

- The equipment must be sanitized periodically and prior to its commissioning.

- After commissioning, you must discard the water produced during the first 30 minutes of use.

- Only qualified personnel, with attitude and hygienic conditions suitable, for the purpose to reduce the risk of internal contamination of the device and its hydraulic system. (For more information, contact the technical service of your distributor).

4. UNPACKING

It is important that before installation and start-up, check the box and condition of the equipment, in order to guarantee that it has not been damaged during transport.

! ATTENTION: Claims for damage during transport must be presented together with the delivery note or invoice to your distributor, attaching the name of the carrier within a maximum period of 24 hours after receipt of the merchandise.

Extract the equipment and accessories from their cardboard packaging, removing the corresponding protections.

! ATTENTION: Properly dispose of and keep plastic bags out of the reach of children, as they can be a danger to them.

Inside you will find: Water treatment equipment, installation accessories and documentation. The materials used in the packaging are recyclable and must be disposed of in the appropriate selective collection containers or in the specific local center for the recovery of waste materials.



This product cannot be disposed of together with normal urban waste. When the useful life of the equipment has ended, it must be delivered to the company or centre where the device was purchased, or to a Recycling Point or specific local center for the recovery of materials, indicating that it has electrical and electronic components. The correct collection and treatment of unusable devices contributes to preserving natural resources and also to avoiding potential risks to public health.

ment of unusable devices contributes to preserving natural resources and also to avoiding potential risks to public health.

5. FACILITY

The installation of your osmosis equipment must be carried out by sufficiently qualified personnel. Please read this manual beforehand and consult your local dealer case of doubt.

! ATTENTION: Since the appliance to be installed improves the quality of the water to be consumed, all the tools to be used for assembly and installation must be clean and in no case may they be contaminated, impregnated with grease, oils or oxides. Use tools exclusively for cutting tubes, handling the membrane, etc. Keep them clean and disinfect them periodically.

! ATTENTION: The work must be carried out with an attitude and in adequate hygienic conditions, taking extreme precautions in everything related to materials and components that are going to be in touch with the water to be treated or consumed.

(For more information, contact your dealer).

! ATTENTION: Avoid the risk of external contamination equipment due to improper handling, using gloves, hand sanitizing gel or washing hands as many times as necessary throughout the installation, start-up and maintenance.

The most frequent place for the installation of the equipment is usually under the kitchen sink or in an adjoining cabinet.

Install the faucet, hydraulically and electrically, to the equipment - drain collar and inlet adapter and connect them to the respective connectors of the equipment (5, 6, 6.1 and 7).

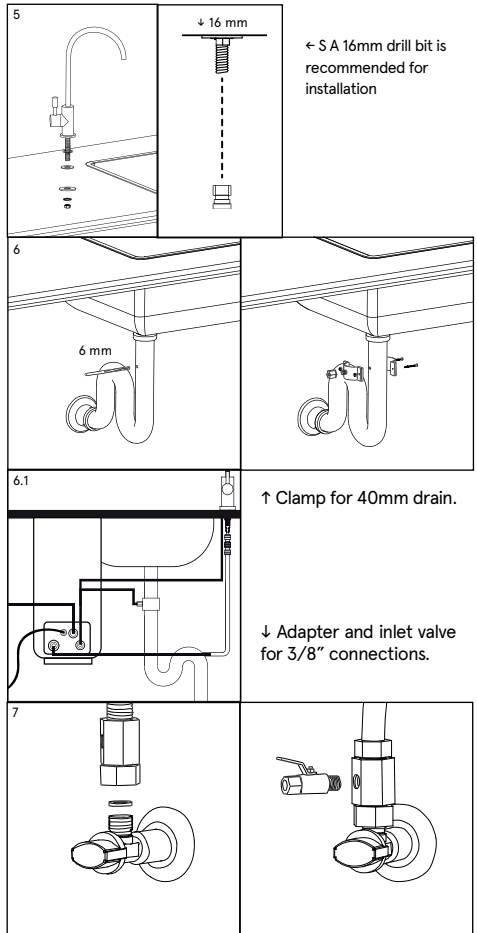

See hydraulic diagram on page 21.

! ATTENTION: Some of the installation accessories may vary depending on the model and the region in which the equipment is distributed.

5.1. MIX KIT

- If you want to increase the pH, the conductivity and the concentration of chlorine at the outlet, you must carry out the installation according to the following diagram and using the corresponding components included in the mixing kit (consult your distributor).

- After start-up, open the tap and with the corresponding meter for the parameter of interest, measure the water dispensed by the tap and slowly and progressively open the mixing valve until the desired parameter is achieved.

- The water dispensed must comply with the potability requirements established by the European Directive 98/83 or corresponding national legislation that transposes it.

5.2. INSTALLATION OF THE FILTERS

- Remove the protective plastic from the filters.
- Install the number 1 prefilter (PP) in position.
- Insert it inside (8) of the corresponding cartridge and close the cap by turning it clockwise with the key above administered (9).
- Carry out the same procedure with the other filters below following the sequence of numbers.
- After completing the installation of the filters, open the inlet valve and the tap of the equipment during 10 minutes.

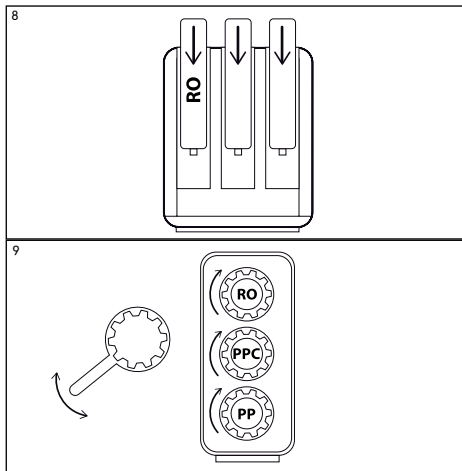

6. START UP

6.1. FILTER RINSE

· It is necessary to eliminate the dust that the carbon in grains of the filter that is generated during the transport and manipulation of the equipment. This dust must be eliminated since it could partially or completely clog the membrane as well as cause the equipment to malfunction. To do this, first open the water inlet valve. Next, electrically connect the device. Then press the flushing button. The unit will perform a flushing of the filters.

6.2. EQUIPMENT SANITIZATION

· Sanitize the equipment according to the model and procedure indicated by the manufacturer (see the Sanitization Procedure). If in doubt, consult your dealer.

6.3. SYSTEM SEALS, STOP AND START

· Closing the faucet of the equipment on the worktop and keep the equipment hydraulically or electrically powered conducting an eye check of the system to ensure that there are no leaks (for about 5 min.).

Open the dispensing tap. The device should be activated and supply water. Close the tap again and check that the equipment stops.

6.4. RINSE AND CLEAN

· Open the faucet of the equipment and measure the quality of the water that is being produced. With a conductivity or TDS meter, check that the reduction of salts obtained is adequate with respect to the water to be treated (14).

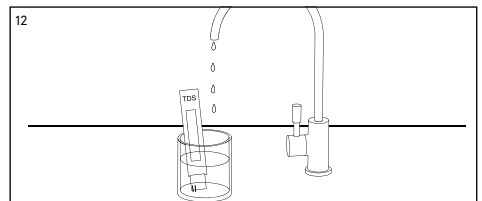

! ATTENTION: *if you detect that the water dispensed does not comply with current national legislation, perform the measurement again. If the deviation persists, close the inlet valve, empty by opening the tap and disconnect it electrically. Contact your technical service.*

· To finish, clean with single-use blotting paper inside and at the bottom of the equipment, in order to remove any water that could have fallen into it, as it could cause a false alarm and block the system.

7. MAINTENANCE

! ATTENTION: *Some components of your equipment, such as the pre-filters and the membrane, are consumables that have a limited service life.*

The duration will depend on the quality of the local water, consumption, type of use and specific aspects of the water to be treated, such as extreme turbidity, high chlorination, excess iron, etc.

! ATTENTION: *In order to guarantee the quality of the water supplied by your equipment, regular maintenance must be performed.*

RECOMMENDED MAINTENANCE

Prefilter 1 PP = 12 months or 1500Lts. *
Prefilter 2 PPC = 12 months or 1500Lts. *
RO membrane = 48 months or 6000 Lts. *
Prefilter K33 = 12 months or 1500Lts. *

* Lts. Litres of water produced.

Maintenance must be carried out by trained personnel, who must handle the equipment properly, as well as use original spare parts to maintain the characteristics, warranty, certifications and performance of the equipment and thus preserve the quality of the water dispensed.

! **ATTENTION:** *The use of non-original spare parts, installation outside the limits of operation and start-up, maintenance or inadequate use, may lead to the loss of the guarantee, as well as the invalidation of the certifications to which it has been applied to the unit.*

An excess of some compounds (total chlorine, turbidity, hardness, etc...) can cause a reduction in the life of filters and certain components. These maintenances will vary.

Your distributor will estimate the duration of the consumables based on the characteristics of the water to be treated and the expected consumption in each case.

! **ATTENTION:** *All consumables are supplied with an individual packaging specially designed to guarantee hygienic storage and transport conditions. Take extreme hygienic precautions after removing the consumables from their packaging and during handling of the different connectors and components.*

! **ATTENTION:** *Before disassembling the equipment, have ready all the material you will need to carry out the maintenance operations (read section 5 Installation) and the necessary space for it. Work in a properly lit place, in adequate hygienic conditions and with enough space to carry out operations comfortably.*

- Change filters properly. Ensure the tightness of the joints and the original hydraulic configuration of the system as recommended by the manufacturer.
- Sanitize the equipment following the indications described in the Sanitation Procedure.
- For more information, consult the technical sheet of the equipment. If you have any other questions, consult your dealer.

! **ATTENTION:** *Use gloves or adequate personal protection measures, if you use chemical products during sanitization.*

Hydraulic scheme.

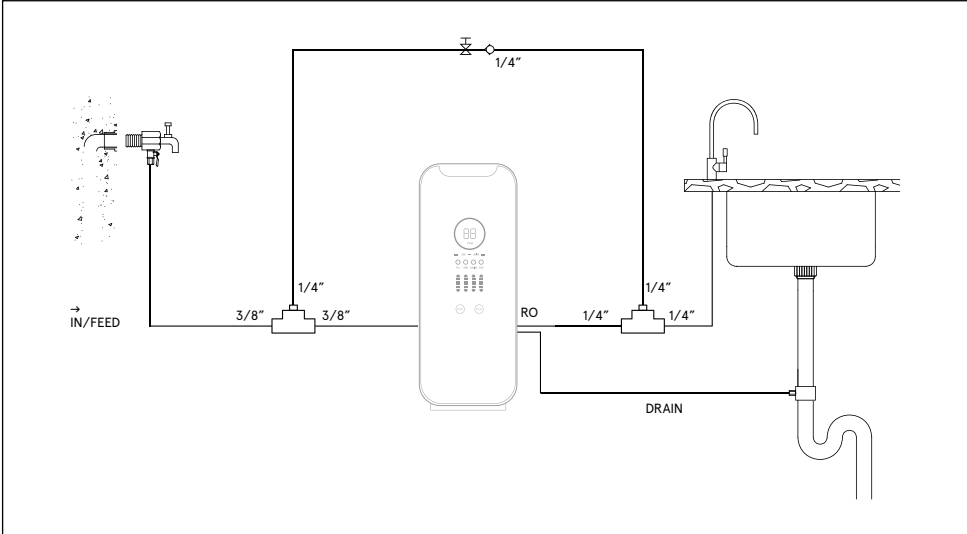

SANITIZATION PROCEDURE

1. SANITIZATION

Necessary material:

- Manual valve.
- Dosing housing and connectors.
- Hydrogen peroxide 3% (0.5L).
- Brush.
- Single use vinyl gloves.
- Easy-rinse soap or detergent.
- Alimentary approved lubricant.
- Detector strips of hydrogen peroxide.
- Sanitizing spray.
- Paper towels.

Sanitize the equipment during start-up, when appropriate (whenever there is a risk of contamination of the equipment due to handling components in contact with water) or with the indicated periodicity. To do this, follow the steps below:

! ATTENTION: The water used during sanitization must be drinking water (from the public distribution network, complying with the corresponding potability requirements of RD 140 / 2003, directive European 98 / 83 or current local legislation).

- Open the tap and let the water recirculate in order to renew the water inside the equipment.
- Close the inlet valve (1) and open the dispenser tap (2) to reduce the pressure in the equipment.

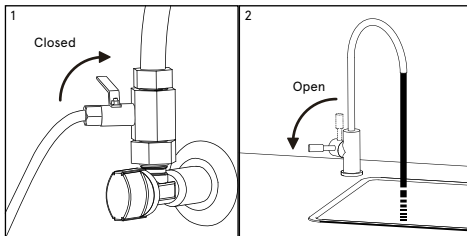

• Change filters and flush them as indicated in the corresponding section of the equipment's Technical Manual. Sanitization must be carried out with the new prefilters and postfilters installed and properly rinsed beforehand (properly removing carbon dust from them).

- Use single (3) use latex gloves to handle sanitizing products.

! ATTENTION: Extreme hygienic measures during the handling of the filters, the membrane and equipment components in contact with water. Wear disposable gloves or wash your hands as many times as necessary to avoid risks of contamination of the equipment.

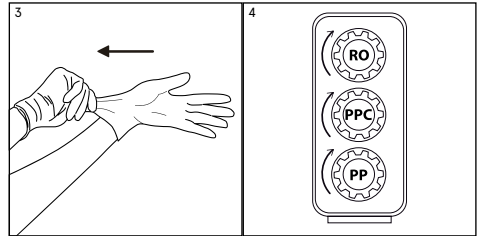

• To perform sanitization of the equipment, the filters must be fitted in their housings (4).

• In case you replace a deteriorated membrane or a filter at the end of its useful life, remove the deteriorated one for disposal and clean the inside of the housing and the connections with a brush (which must be kept clean and disinfected) together with soap or easy-rinsing detergent (which generates little bubbles) and suitable for cleaning surfaces in contact with food (5). Subsequently, rinse the housings and connections properly, ensuring that all traces of detergent are removed.

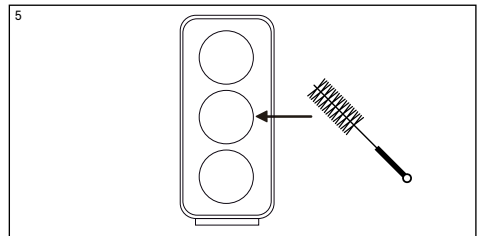

2. TREATMENT OF THE PREFILTER, THE MEMBRANE AND THE POSTFILTER

• Disconnect the inlet tube to the equipment marked "feed-entrance", and insert the dosing housing between the inlet valve and the water inlet of the equipment(6). For greater convenience and ease of access during sanitization and the opening and closing operations of the inlet valve, you can insert a manual valve in the closed position, together with the sanitizing dosing housing, which will perform the same functions as the manual inlet shut-off valve to the equipment.

- Once the assembly is installed, close the new manual inlet valve and open the inlet valve connected to the wall adapter (7). The dosing housing must be empty.
- Pour 0.25 liters of Hydrogen Peroxide into the dosing housing installed in the entrance of the equipment (8). Screw the body correctly to its head.
- The manual inlet valve and the faucet must be closed. Connect the equipment to the power supply.
- Open the water inlet valve to the equipment and the faucet, allowing it to start up and letting the Hydrogen Peroxide pass into it. Fill a jar with 1L with tap water. Before closing the tap and close the inlet tap again to lower the pressure. Fill the dispenser again with 0.25l of hydrogen peroxide and pour out 1 more litre of water. Close the tap. At this time, the entire circuit contains sanitizing liquid.
- After elapsed 10 min has elapsed. Open the dispenser tap (9) and let the mains water circulate for 5 minutes.
- Empty the dosing housing. Before opening it, have a container within easy reach of where you can empty it, as it may be full of water.

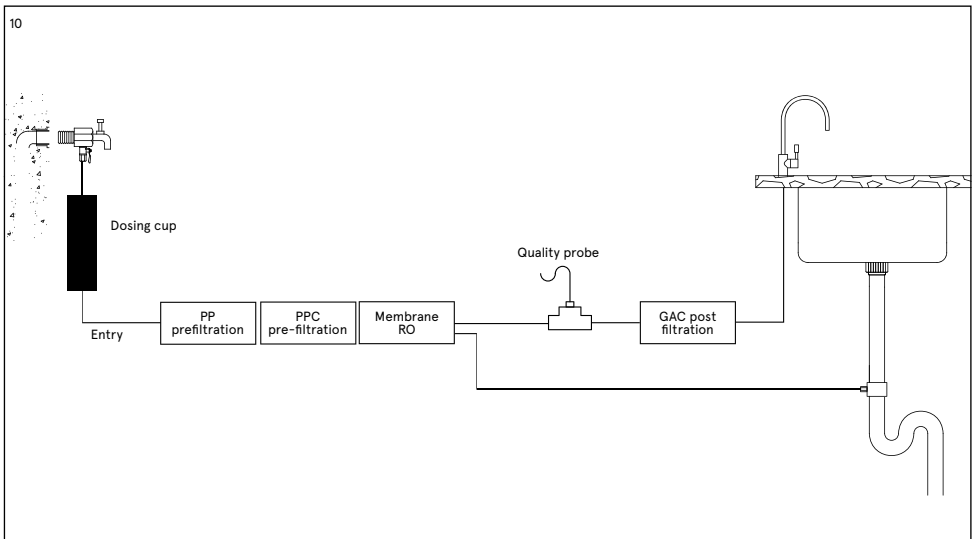
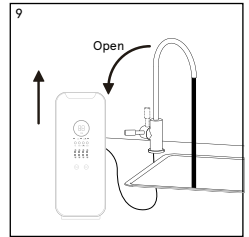
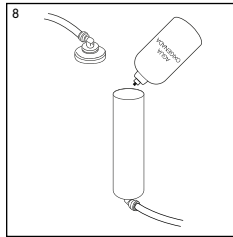
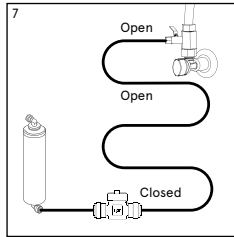
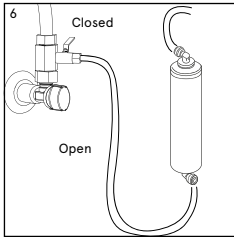

- Pay special attention to sanitizing the faucet spout. Use the sanitizing spray (or, failing that, hydrogen peroxide, dosing it in such a way that it penetrates the tap spout) and single-use blotting paper. Spray the spray on the tap nozzle (11), rub the spout and the tap nozzle with the disposable paper and do not touch it directly with your hands (12).

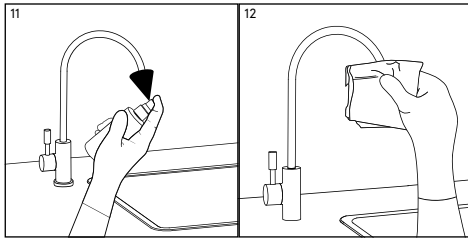

3. RINSE

- Given that the sanitizing and rinsing does not ensure complete removal of carbon dust from new filters or sanitizing residues, rinse the osmosis equipment with plenty of water after each sanitizing, circulating suitable quality mains water for 5 minutes or more. Discard the first 5 liters of water before consuming it.
- Proceed to rinse the pre-filter each time it is replaced and prior to each equipment sanitization.
- Rinse the pre-filter, preferably isolated from the rest of the equipment even before its installation.
- Do the rinse with abundant water that complies with applicable local regulations regarding water potability parameters.
- Fill the pre-filter slowly in order to evacuate the contained air and avoid internal turbulence that would alter the different filtration stages. When the water comes out of the outlet opening, gradually increase the flow rate. Extract a minimum of 4L and make sure that this water no longer contains dust from the carbon.
- Keep the filter in the same position throughout the process, the position it will occupy once installed.
- At the end take a kitchen paper towel, dry all the parts that could have gotten wet and especially the Aquastop leak detection probe (if the equipment incorporates it).

DATA SHEET

FOR REVERSE OSMOSIS EQUIPMENT

1. TECHNICAL CHARACTERISTICS

APP

Water treatment

Inverse osmosis

Use

Improvement of the characteristics of drinking water (that complies with the requirements of the European Directive on water of human consumption 98/83 or its national transpositions in the different member states of the European Community).

Modifications due to reduction or contribution

- Reverse osmosis water treatment is capable of reducing concentrations of salts and other substances in high percentages.
- Minimum reduction* of certain compounds and parameters:

Sodium: 90%.

Calcium: 90%.

Sulfate: 90%.

Chloride: 90%.

Total hardness: 90%.

Conductivity: 90%.

* Depending on the characteristics of the water to be treated (at the membrane outlet). These values can vary in depending on the type of post-filter that the equipment incorporates and/or regulation of the mixing valve (if it incorporates).

OPERATING LIMITS

EQUIPMENT WITH PUMP

Pressure (max/min):	4 bar - 1 bar (400kPa-100kPa).
TDS (max):	1500ppm.
Temperature (max/min):	38°C - 5°C.
Hardness (max):	15°HF. **

Control type: Maximum pressure switch
Inlet control solenoid valve.
Flushing solenoid valve.

Security system: Minimum pressure switch.
Electronic leak sensor.
Water quality control.
Maintenance warning

Dimensions (A x B x C in mm): 385 x 152 x 453.
Weight (in kg, including all accessories): 12,45.

Input connection: 3/8".
Drain connection: 1/4".
Tap connection: 1/4".
Wall adapter: 3/8" M-F, *****
Drain collar: Clamp for 40 mm drain pipe.

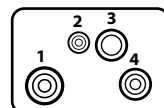
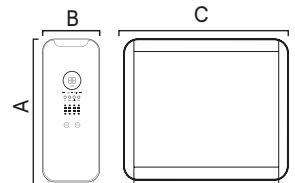

1. Desalinated water^{1/4}
2. Electrical power supply
3. Input 3/8
4. Drain^{1/4}

PP prefilter

1 x sediment 2,5"

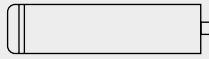

PPC prefilter

1 x combined sediment + carbon 2'5"



RO membrane

800 GPD. Water flow: 1,7 lpm

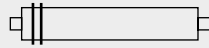

T33 postfilter

1 x granulated carbon 2"



Power supply:
Power adapter:
Type of tap:
Production:

24 VDC 4 A.
100-240 Vac 50 / 60 Hz
Special 1-way tap.
1,7 lpm.
(inlet water conditions: 450 µS, 15 °HF, 17 °C and 3 bar)

ESQUEMA HIDRÁULICO

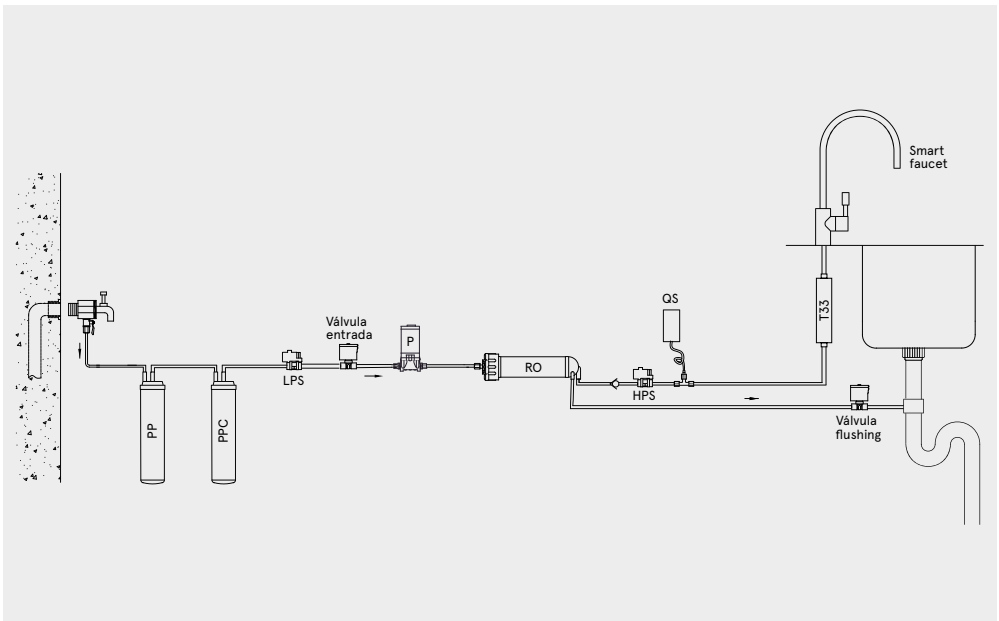

HYDRAULIC CONNECTION DIAGRAM

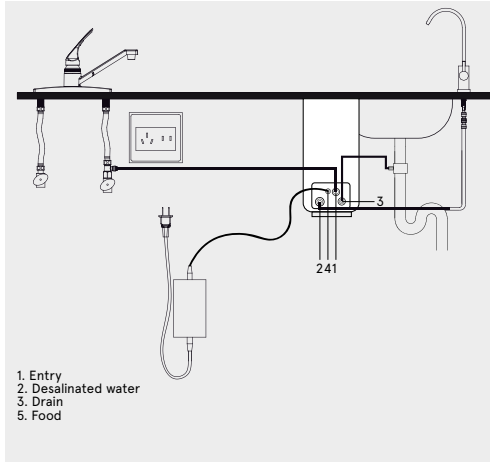

- * For salinities greater than 1500ppm consult your distributor.
- ** Higher hardness may reduce the life and workings of certain components.
- *** Maximum accumulation depending on the inlet pressure.
- **** Flow rates may vary by 20% depending on the temperature, pressure and specific composition of the water to be treated.
- ***** May vary depending on the model.

DISTRIBUTED BY:

IONFILTER
Aiguafreda, 8
Pol. Ind. L'Ametlla Park
08480, L'Ametlla del Valles
Barcelona - Spain
T. 902 305 310 F. +34 936 934 329

2. UNIT'S FUNCTIONING

· The mains water to be treated enters in the equipment going through the prefiltration stage that incorporates a sediment filter and another pp+carbon block. In this filtration stage, suspended particles, chlorine, its derivatives and other organic substances are retained.

· The unit incorporates a minimum pressure switch (LPS) to protect the pump against mains pressure loss.

· The flow of water into of the equipment is controlled by a cut-off solenoid valve (Si).

· The water, after being treated in the filtration stage, is pumped towards the reverse osmosis (RO) membrane. The equipment incorporates a pump (P) to increase the pressure. The pressure of the water on the membrane makes the reverse osmosis process possible.

· Before leaving the tap, the water passes by the carbon postfilter, which improves the taste.

· Rejected water or water with excess salts and other dissolved substances are directed to the drain for disposal.

· Direct flow units control start and stops by means of a pressure switch (HPS)

· The equipment incorporates different functional and/or security systems, managed by a state-of-the-art electronic module:

· Minimum pressure switch (LPS). When the system detects low inlet water pressure, it will block the equipment to protect the pump from running dry. This will keep the unit blocked until the power is turned off and back on.

· Electronic leak detection system (L). When the system detects this situation, it blocks the equipment by emitting an acoustic and light signal informing the regard. The unit will remain blocked until the detection probe is dry.

· Probe for measuring the conductivity of the water produced to assess the state of the membrane and components (Q). when dispensing water from the tap, the system will measure the conductivity of the produced water.

· Automatic notification of filter change, in order to inform the user that the appropriate maintenance must be carried out to guarantee the quality of the water dispensed. To guarantee the quality of the water dispensed, the equipment must be properly maintained, remaining blocked, until the corresponding actions are carried out.

3. FEATURES

FUNCTION	ACTION
1. Flushing at machine start-up.	Whenever it is electrically connected the system will flush the RO membrane for 20 seconds.
2. Flush after use accumulated.	When the machine accumulates more than 20 minutes of operation, a flushing of the RO membrane 3 times for 3 seconds, with a 2 second interval between flushes.
3. Opening of the faucet.	The system is put into operation in normal way.
4. Closing the faucet.	The system stops producing water. If it does not accumulate more than 20 minutes of operation, it performs a 5-second flush and goes on standby.

3.3. FAULT IDENTIFICATION AND RESOLUTION

FUNCTION	INDICATIONS	ACTIONS
1. More than 3 hours continued operation	· Led check flashes red	Disconnect the machine electrically. Reconnect and keep power button pressed for 1.5 sec.
2. Lack of pressure in the inlet water	· All the lights are flashing white · 5 second beep	Disconnect the machine electrically. Reconnect and keep pressed the power for 1.5 sec.
3. Water leak	· Led flushing and check blink on white · 5 seconds of beeps	Disconnect the equipment and dry the sensor. Reconnect to re-move the alarm remains on, contact the SAT.
4. Filter life exhausted	· Fixed machine filter red led	To guarantee the quality and characteristics of the water dispensed by the equipment, in the event that maintenance is not carried out 3 months after the notice or scheduled date, the equipment will stop operating for safety reasons, stopping dispensing water. Call the technical service.

4. WARRANTY

The distributor guarantees the equipment for a period of three years against any lack of conformity that is detected in them, as provided in RD 1/2007 of November 16 (consolidated text of the General Law for the defense of consumers and users).

- The guarantee includes the repair and replacement of defective parts by personnel authorized by the distributor or by the official technical assistance service (SAT) at the place of installation or in their workshops. Labor and shipping costs that may be generated are included in the guarantee.
- The distributor is exempt from providing a guarantee in the cases of parts subject to natural wear, lack of maintenance, bumps or other non-conformities that are a consequence of improper use of the equipment or inadequate according to the operating conditions and limits indicated by its manufacturer. Likewise, the guarantee loses effectiveness in cases of poor handling and use of the equipment or in those cases in which they have been modified or repaired by personnel other than the distribution company or official SAT.
- Parts replaced under warranty will remain the property of the dealer.
- The distributor is responsible for the lack of conformity of the equipment when it refers to the origin, identity or suitability of the products, according to their nature and purpose. Taking into account the characteristics of the equipment, it is essential for the guarantee to cover the lack of conformity, the fulfillment of the technical conditions of installation and operation. Failure to comply with these conditions may result in the absence of a guarantee, taking into account the relevance of the destination of the equipment and the operating conditions and limits in which it must operate.
- The distributor must guarantee that the installed equipment is suitable for improving the quality of the water to be treated in particular, according to the characteristics of the equipment and current regulations.
- The distributor must guarantee the correct installation and start-up of the equipment as indicated by the manufacturer and current regulations and will also be responsible for the lack of conformity derived from an incorrect application, installation or start-up of the equipment.
- For any warranty claim, it is necessary to present the purchase invoice. The term of three years is computed from the purchase of the equipment from the distributor.
- If during the period of warranty your equipment has a problem, contact your distributor.

The equipment is installed and operating satisfactorily for the client and for the record:

* Treatment prior to equipment:

* Hardness of entrance to the equipment(°F):

* Input TDS to the equipment (ppm):

* TDS produced water (ppm):

* Equipment inlet pressure(bar):

*** Result of the installation and commissioning sheet:**

Correct:

Other:

The owner of the equipment has been adequately and clearly informed of the use, handling and maintenance that the equipment requires to guarantee its correct operation and the quality of the water produced. A maintenance contract is offered for this purpose.

***Ref. Contract of maintenance:**

ACCEPT the maintenance contract

DO NOT ACCEPT the maintenance contract

In case you need information, report a breakdown or malfunction, request maintenance or intervention by a technician, first read the sections on operation, detection and resolution of problems in this manual and contact the dealer or company that sold you your equipment.

COMPANY AND/OR AUTHORIZED INSTALLER, DATE AND SIGNATURE: NÚMERO DE SERIE:



NOTE FOR THE COMPANY AND/OR TECHNICIAN/INSTALLER AUTHORIZED: the data marked with the symbol * must be filled in by the installer technician and transcribe it himself from the INSTALLATION RECORD sheet.



5. INSTALLATION RECORD SHEET



NOTES FOR THE TECHNICIAN/INSTALLER: read this carefully Handbook. In case of any doubt, contact the Technical Assistance Service (SAT) of your distributor. The data marked with the symbol * must be filled in by the technician/installer and transcribed by him/her on the WARRANTY sheet. This sheet must be kept by the installer and may be required by the distributor in order to improve after-sales service and customer service to the client. The technician who performs the installation and commissioning of the equipment must have the training proper technique.

DATA ON THE APPLICATION OF THE EQUIPMENT:

Origin of water to treat:

PUBLIC SUPPLY

OTHERS

* Treatment prior to equipment:

* Hardness of entrance to the equipment(°F):

* Input TDS to the equipment (ppm):

* TDS produced water (ppm):

* Equipment inlet pressure(bar):

* Equipment inlet chlorine concentration (ppm):

CONTROL OF THE INSTALLATION STEPS:

Sanitization according to protocol described
Maximum pressure switch setting
Review and fittings
Pressurized system tightness

Produced water TDS (countertop tap) (ppm)
Clearly report the use, handling and maintenance that the equipment required to guarantee its proper functioning and the quality of the water produced.

COMMENTS

* Result of installation and commissioning:

CORRECT (equipment installed and working correctly. Produced water suitable for the application).

OTHERS :

IDENTIFICATION OF THE TECHNICIAN/INSTALLER AUTHORIZED:

COMPANY AND/OR AUTHORIZED INSTALLER, DATE AND SIGNATURE:

CONFORMITY FROM THE EQUIPMENT OWNER:

I have been clearly informed of the use, handling and maintenance required by the installed equipment, having been offered a maintenance contract and informed of how to contact a Customer Service in case of requesting information, communication of failure or malfunction, request for maintenance or intervention of a technician .

Comments:

*Ref. Contract of maintenance:

ACCEPT the maintenance contract

DOES NOT ACCEPT the maintenance contract

Model/Ref.:

Owner:

Street:

Telephone:

Population:

Province:

ZIP:

SERIAL NUMBER:

EQUIPMENT WARRANTY ADDRESSED TO THE DISTRIBUTOR:

The distributor will only be responsible for the substitutions of parts in case of non-conformity. The repair of equipment and the expenses that it entails (labor, shipping costs, travel, etc.) will be assumed by the distributor, in accordance with what was agreed in the general conditions of contracting and sale, for which reason may be subsequently passed on to the manufacturer.



6. MAINTENANCE SERVICE

DATE	TYPE OF SERVICE	NAME, SIGNATURE AND STAMP OF THE AUTHORIZED TECHNICIAN	
<input type="text"/>	<input type="radio"/> START UP		
<input type="text"/>	<input type="radio"/> COMPLETE MAINTENANCE	TECHNICAL <input type="text"/>	<input type="radio"/> ORDINARY <input type="radio"/> EXTRAORDINARY <input type="radio"/> WARRANTY
<input type="text"/>	<input type="radio"/> PREPARATION	STAMP	
<input type="text"/>	<input type="radio"/> SANITIZATION	<input type="text"/>	
<input type="text"/>	<input type="radio"/> OTHERS		
<input type="text"/>	<input type="radio"/> COMPLETE MAINTENANCE	TECHNICAL <input type="text"/>	<input type="radio"/> ORDINARY <input type="radio"/> EXTRAORDINARY <input type="radio"/> WARRANTY
<input type="text"/>	<input type="radio"/> PREPARATION	STAMP	
<input type="text"/>	<input type="radio"/> HIGIENIZACIÓN	<input type="text"/>	
<input type="text"/>	<input type="radio"/> OTROS		
<input type="text"/>	<input type="radio"/> COMPLETE MAINTENANCE	TECHNICAL <input type="text"/>	<input type="radio"/> ORDINARY <input type="radio"/> EXTRAORDINARY <input type="radio"/> WARRANTY
<input type="text"/>	<input type="radio"/> PREPARATION	STAMP	
<input type="text"/>	<input type="radio"/> SANITIZATION	<input type="text"/>	
<input type="text"/>	<input type="radio"/> OTHERS		
<input type="text"/>	<input type="radio"/> COMPLETE MAINTENANCE	TECHNICAL <input type="text"/>	<input type="radio"/> ORDINARY <input type="radio"/> EXTRAORDINARY <input type="radio"/> WARRANTY
<input type="text"/>	<input type="radio"/> PREPARATION	STAMP	
<input type="text"/>	<input type="radio"/> SANITIZATION	<input type="text"/>	
<input type="text"/>	<input type="radio"/> OTHERS		
<input type="text"/>	<input type="radio"/> COMPLETE MAINTENANCE	TECHNICAL <input type="text"/>	<input type="radio"/> ORDINARY <input type="radio"/> EXTRAORDINARY <input type="radio"/> WARRANTY
<input type="text"/>	<input type="radio"/> PREPARATION	STAMP	
<input type="text"/>	<input type="radio"/> SANITIZATION	<input type="text"/>	
<input type="text"/>	<input type="radio"/> OTHERS		

6. MAINTENANCE SERVICE

DATE	TYPE OF SERVICE	NAME, SIGNATURE AND STAMP OF THE AUTHORIZED TECHNICIAN	
<input type="text"/>	<input type="radio"/> START UP		
<input type="text"/>	<input type="radio"/> COMPLETE MAINTENANCE	TECHNICAL <input type="text"/>	<input type="radio"/> ORDINARY <input type="radio"/> EXTRAORDINARY <input type="radio"/> WARRANTY
<input type="text"/>	<input type="radio"/> PREPARATION	STAMP	
<input type="text"/>	<input type="radio"/> SANITIZATION	<input type="text"/>	
<input type="text"/>	<input type="radio"/> OTHERS		
<input type="text"/>	<input type="radio"/> COMPLETE MAINTENANCE	TECHNICAL <input type="text"/>	<input type="radio"/> ORDINARY <input type="radio"/> EXTRAORDINARY <input type="radio"/> WARRANTY
<input type="text"/>	<input type="radio"/> PREPARATION	STAMP	
<input type="text"/>	<input type="radio"/> SANITIZATION	<input type="text"/>	
<input type="text"/>	<input type="radio"/> OTHERS		
<input type="text"/>	<input type="radio"/> COMPLETE MAINTENANCE	TECHNICAL <input type="text"/>	<input type="radio"/> ORDINARY <input type="radio"/> EXTRAORDINARY <input type="radio"/> WARRANTY
<input type="text"/>	<input type="radio"/> PREPARATION	STAMP	
<input type="text"/>	<input type="radio"/> SANITIZATION	<input type="text"/>	
<input type="text"/>	<input type="radio"/> OTHERS		
<input type="text"/>	<input type="radio"/> COMPLETE MAINTENANCE	TECHNICAL <input type="text"/>	<input type="radio"/> ORDINARY <input type="radio"/> EXTRAORDINARY <input type="radio"/> WARRANTY
<input type="text"/>	<input type="radio"/> PREPARATION	STAMP	
<input type="text"/>	<input type="radio"/> SANITIZATION	<input type="text"/>	
<input type="text"/>	<input type="radio"/> OTHERS		
<input type="text"/>	<input type="radio"/> COMPLETE MAINTENANCE	TECHNICAL <input type="text"/>	<input type="radio"/> ORDINARY <input type="radio"/> EXTRAORDINARY <input type="radio"/> WARRANTY
<input type="text"/>	<input type="radio"/> PREPARATION	STAMP	
<input type="text"/>	<input type="radio"/> SANITIZATION	<input type="text"/>	
<input type="text"/>	<input type="radio"/> OTHERS		



6. MAINTENANCE SERVICE

DATE	TYPE OF SERVICE	NAME, SIGNATURE AND STAMP OF THE AUTHORIZED TECHNICIAN	
<input type="text"/>	<input type="radio"/> START UP		
<input type="text"/>	<input type="radio"/> COMPLETE MAINTENANCE	TECHNICAL	
<input type="text"/>	<input type="radio"/> PREPARATION	STAMP	<input type="radio"/> ORDINARY
<input type="text"/>	<input type="radio"/> SANITIZATION	<input type="text"/>	<input type="radio"/> EXTRAORDINARY
<input type="text"/>	<input type="radio"/> OTHERS		<input type="radio"/> WARRANTY
<input type="text"/>	<input type="radio"/> COMPLETE MAINTENANCE	TECHNICAL	
<input type="text"/>	<input type="radio"/> PREPARATION	STAMP	<input type="radio"/> ORDINARY
<input type="text"/>	<input type="radio"/> HIGIENIZACIÓN	<input type="text"/>	<input type="radio"/> EXTRAORDINARY
<input type="text"/>	<input type="radio"/> OTROS		<input type="radio"/> WARRANTY
<input type="text"/>	<input type="radio"/> COMPLETE MAINTENANCE	TECHNICAL	
<input type="text"/>	<input type="radio"/> PREPARATION	STAMP	<input type="radio"/> ORDINARY
<input type="text"/>	<input type="radio"/> SANITIZATION	<input type="text"/>	<input type="radio"/> EXTRAORDINARY
<input type="text"/>	<input type="radio"/> OTHERS		<input type="radio"/> WARRANTY
<input type="text"/>	<input type="radio"/> COMPLETE MAINTENANCE	TECHNICAL	
<input type="text"/>	<input type="radio"/> PREPARATION	STAMP	<input type="radio"/> ORDINARY
<input type="text"/>	<input type="radio"/> SANITIZATION	<input type="text"/>	<input type="radio"/> EXTRAORDINARY
<input type="text"/>	<input type="radio"/> OTHERS		<input type="radio"/> WARRANTY
<input type="text"/>	<input type="radio"/> COMPLETE MAINTENANCE	TECHNICAL	
<input type="text"/>	<input type="radio"/> PREPARATION	STAMP	<input type="radio"/> ORDINARY
<input type="text"/>	<input type="radio"/> SANITIZATION	<input type="text"/>	<input type="radio"/> EXTRAORDINARY
<input type="text"/>	<input type="radio"/> OTHERS		<input type="radio"/> WARRANTY

6. MAINTENANCE SERVICE

DATE	TYPE OF SERVICE	NAME, SIGNATURE AND STAMP OF THE AUTHORIZED TECHNICIAN	
<input type="text"/>	<input type="radio"/> START UP		
<input type="text"/>	<input type="radio"/> COMPLETE MAINTENANCE	TECHNICAL <input type="text"/>	<input type="radio"/> ORDINARY <input type="radio"/> EXTRAORDINARY <input type="radio"/> WARRANTY
<input type="text"/>	<input type="radio"/> PREPARATION	STAMP	
<input type="text"/>	<input type="radio"/> SANITIZATION	<input type="text"/>	
<input type="text"/>	<input type="radio"/> OTHERS		
<input type="text"/>	<input type="radio"/> COMPLETE MAINTENANCE	TECHNICAL <input type="text"/>	<input type="radio"/> ORDINARY <input type="radio"/> EXTRAORDINARY <input type="radio"/> WARRANTY
<input type="text"/>	<input type="radio"/> PREPARATION	STAMP	
<input type="text"/>	<input type="radio"/> SANITIZATION	<input type="text"/>	
<input type="text"/>	<input type="radio"/> OTHERS		
<input type="text"/>	<input type="radio"/> COMPLETE MAINTENANCE	TECHNICAL <input type="text"/>	<input type="radio"/> ORDINARY <input type="radio"/> EXTRAORDINARY <input type="radio"/> WARRANTY
<input type="text"/>	<input type="radio"/> PREPARATION	STAMP	
<input type="text"/>	<input type="radio"/> SANITIZATION	<input type="text"/>	
<input type="text"/>	<input type="radio"/> OTHERS		
<input type="text"/>	<input type="radio"/> COMPLETE MAINTENANCE	TECHNICAL <input type="text"/>	<input type="radio"/> ORDINARY <input type="radio"/> EXTRAORDINARY <input type="radio"/> WARRANTY
<input type="text"/>	<input type="radio"/> PREPARATION	STAMP	
<input type="text"/>	<input type="radio"/> SANITIZATION	<input type="text"/>	
<input type="text"/>	<input type="radio"/> OTHERS		
<input type="text"/>	<input type="radio"/> COMPLETE MAINTENANCE	TECHNICAL <input type="text"/>	<input type="radio"/> ORDINARY <input type="radio"/> EXTRAORDINARY <input type="radio"/> WARRANTY
<input type="text"/>	<input type="radio"/> PREPARATION	STAMP	
<input type="text"/>	<input type="radio"/> SANITIZATION	<input type="text"/>	
<input type="text"/>	<input type="radio"/> OTHERS		

NOTES

NOTES

NOTES

NOTES
